

# PC 5/11-ST1-7,62 - PCB connector



1777817

<https://www.phoenixcontact.com/us/products/1777817>

Please be informed that the data shown in this PDF document is generated from our online catalog. Please find the complete data in the user documentation. Our general terms of use for downloads are valid.

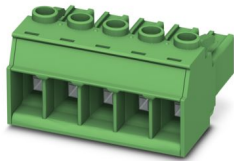

PCB connector, nominal cross section: 6 mm<sup>2</sup>, color: green, nominal current: 32 A, rated voltage (III/2): 1000 V, contact surface: Sn, contact connection type: Socket, number of potentials: 11, number of rows: 1, number of positions: 11, number of connections: 11, product range: PC 5/..-ST1, pitch: 7.62 mm, connection method: Screw connection with tension sleeve, screw head form: H1L Slotted Phillips recess, conductor/PCB connection direction: 0 °, locking clip: - Locking clip, plug-in system: COMBICON PC 5, locking: without, mounting method: without, type of packaging: packed in cardboard

## Your advantages

- Well-known connection principle allows worldwide use
- Low temperature rise, thanks to maximum contact force
- Allows connection of two conductors
- Integrated double steel spring provides additional safety in the event of temperature and power fluctuations
- 600 V UL approval in the smallest of dimensions

## Commercial data

Item number	1777817
Packing unit	50 pc
Minimum order quantity	50 pc
Sales key	AA04
Product key	AADABA
GTIN	4046356522953
Weight per piece (including packing)	48.17 g
Weight per piece (excluding packing)	48.15 g
Customs tariff number	85366990
Country of origin	DE

# PC 5/11-ST1-7,62 - PCB connector



1777817

<https://www.phoenixcontact.com/us/products/1777817>

## Technical data

### Product properties

Product type	PCB connector
Product family	PC 5/...-ST1
Product line	COMBICON Connectors L
Type	Standard
Number of positions	11
Pitch	7.62 mm
Number of connections	11
Number of rows	1
Number of potentials	11
Mounting type	without

### Electrical properties

#### Properties

Nominal current $I_N$	32 A
Nominal voltage $U_N$	1000 V
Contact resistance	0.4 mΩ
Rated voltage (III/3)	1000 V
Rated surge voltage (III/3)	8 kV
Rated voltage (III/2)	1000 V
Rated surge voltage (III/2)	8 kV
Rated voltage (II/2)	1000 V
Rated surge voltage (II/2)	6 kV

### Connection data

#### Connection technology

Type	Standard
Connector system	COMBICON PC 5
Nominal cross section	6 mm <sup>2</sup>
Contact connection type	Socket

#### Interlock

Locking type	without
Mounting type	without

#### Conductor connection

Connection method	Screw connection with tension sleeve
Conductor/PCB connection direction	0 °
Conductor cross-section rigid	0.2 mm <sup>2</sup> ... 10 mm <sup>2</sup>
Conductor cross-section flexible	0.2 mm <sup>2</sup> ... 6 mm <sup>2</sup>
Conductor cross-section AWG	24 ... 10

# PC 5/11-ST1-7,62 - PCB connector



1777817

<https://www.phoenixcontact.com/us/products/1777817>

Conductor cross-section flexible, with ferrule without plastic sleeve	0.25 mm <sup>2</sup> ... 6 mm <sup>2</sup>
Conductor cross-section, flexible, with ferrule, with plastic sleeve	0.25 mm <sup>2</sup> ... 4 mm <sup>2</sup>
2 conductors with same cross section, solid	0.2 mm <sup>2</sup> ... 2.5 mm <sup>2</sup>
2 conductors with same cross section, flexible	0.2 mm <sup>2</sup> ... 4 mm <sup>2</sup>
2 conductors with same cross section, flexible, with ferrule without plastic sleeve	0.25 mm <sup>2</sup> ... 1.5 mm <sup>2</sup>
2 conductors with the same cross section, flexible, with TWIN ferrule with plastic sleeve	0.25 mm <sup>2</sup> ... 2.5 mm <sup>2</sup>
Cylindrical gauge a x b / diameter	3.6 mm x 3.1 mm / 3.4 mm
Stripping length	10 mm
Drive form screw head	Slotted Phillips recess (H1L)
Tightening torque	0.5 Nm ... 0.8 Nm (≤ 4 mm <sup>2</sup> is 0.5 Nm to 0.6 Nm, > 4 mm <sup>2</sup> is 0.7 Nm to 0.8 Nm)

## Material specifications

### Material data - contact

Note	WEEE/RoHS-compliant, free of whiskers according to IEC 60068-2-82/JEDEC JESD 201
Contact material	Cu alloy
Surface characteristics	hot-dip tin-plated
Metal surface terminal point (top layer)	Tin (4 - 8 μm Sn)
Metal surface contact area (top layer)	Tin (4 - 8 μm Sn)

### Material data - housing

Color (Housing)	green (6021)
Insulating material	PA
Insulating material group	I
CTI according to IEC 60112	600
Flammability rating according to UL 94	V0
Glow wire flammability index GWFI according to EN 60695-2-12	850
Glow wire ignition temperature GWIT according to EN 60695-2-13	775
Temperature for the ball pressure test according to EN 60695-10-2	125 °C

## Dimensions

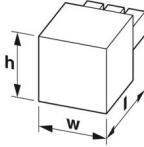
Dimensional drawing	
Pitch	7.62 mm
Width [w]	83.77 mm
Height [h]	19.7 mm

# PC 5/11-ST1-7,62 - PCB connector



1777817

<https://www.phoenixcontact.com/us/products/1777817>

Length [l]	35.25 mm
------------	----------

## Notes

Notes on operation	In accordance with IEC 61984, COMBICON connectors have no switching power (COC). During designated use, they must not be plugged in or disconnected when carrying voltage or under load.
--------------------	--

## Mechanical tests

### Test for conductor damage and slackening

Specification	IEC 60999-1:1999-11
Result	Test passed

### Pull-out test

Specification	IEC 60999-1:1999-11
Conductor cross-section/conductor type/tractive force setpoint/actual value	0.2 mm <sup>2</sup> / solid / > 10 N
	0.2 mm <sup>2</sup> / flexible / > 10 N
	10 mm <sup>2</sup> / solid / > 90 N
	6 mm <sup>2</sup> / flexible / > 80 N
	6 mm <sup>2</sup> / solid / > 80 N
4 mm <sup>2</sup> / flexible / > 60 N	

### Insertion and withdrawal forces

Specification	IEC 60512-13-2:2006-02
Result	Test passed
No. of cycles	50
Insertion strength per pos. approx.	8 N
Withdraw strength per pos. approx.	6.5 N

### Torque test

Specification	IEC 60999-1:1999-11
---------------	---------------------

### Resistance of inscriptions

Specification	IEC 60068-2-70:1995-12
Result	Test passed

### Polarization and coding

Specification	IEC 60512-13-5:2006-02
Result	Test passed

### Visual inspection

Specification	IEC 60512-1-1:2002-02
Result	Test passed

### Dimension check

Specification	IEC 60512-1-2:2002-02
Result	Test passed

## Environmental and real-life conditions

# PC 5/11-ST1-7,62 - PCB connector



1777817

<https://www.phoenixcontact.com/us/products/1777817>

## Vibration test

Specification	IEC 60068-2-6:2007-12
Frequency	10 - 150 - 10 Hz
Sweep speed	1 octave/min
Amplitude	0.35 mm (10 Hz ... 60.1 Hz)
Acceleration	5g (60.1 Hz ... 150 Hz)
Test duration per axis	2.5 h
Test directions	X-, Y- and Z-axis

## Durability test

Specification	IEC 60512-5:1992-08
Impulse withstand voltage at sea level	7.3 kV
Contact resistance R <sub>1</sub>	0.4 mΩ
Contact resistance R <sub>2</sub>	0.5 mΩ
Insertion/withdrawal cycles	50

## Climatic test

Specification	ISO 6988:1985-02
Corrosive stress	0.2 dm <sup>3</sup> SO <sub>2</sub> on 300 dm <sup>3</sup> /40 °C/1 cycle
Thermal stress	100 °C/168 h
Power-frequency withstand voltage	3.31 kV

## Ambient conditions

Ambient temperature (operation)	-40 °C ... 100 °C (dependent on the derating curve)
Ambient temperature (storage/transport)	-40 °C ... 70 °C
Relative humidity (storage/transport)	30 % ... 70 %
Ambient temperature (assembly)	-5 °C ... 100 °C

## Electrical tests

### Thermal test | Test group C

Specification	IEC 60512-5-1:2002-02
Tested number of positions	12

### Insulation resistance

Specification	IEC 60512-3-1:2002-02
Insulation resistance, neighboring positions	>10 <sup>12</sup> Ω

### Air clearances and creepage distances |

Specification	IEC 60664-1:2007-04
Insulating material group	I
Comparative tracking index (IEC 60112)	CTI 600
Rated insulation voltage (III/3)	1000 V
Rated surge voltage (III/3)	8 kV
minimum clearance value - non-homogenous field (III/3)	8 mm
minimum creepage distance (III/3)	12.5 mm

# PC 5/11-ST1-7,62 - PCB connector



1777817

<https://www.phoenixcontact.com/us/products/1777817>

Rated insulation voltage (III/2)	1000 V
Rated surge voltage (III/2)	8 kV
minimum clearance value - non-homogenous field (III/2)	8 mm
minimum creepage distance (III/2)	8 mm
Rated insulation voltage (II/2)	1000 V
Rated surge voltage (II/2)	6 kV
minimum clearance value - non-homogenous field (II/2)	5.5 mm
minimum creepage distance (II/2)	5.5 mm

## Packaging specifications

Type of packaging	packed in cardboard
-------------------	---------------------

Drawings

Dimensional drawing

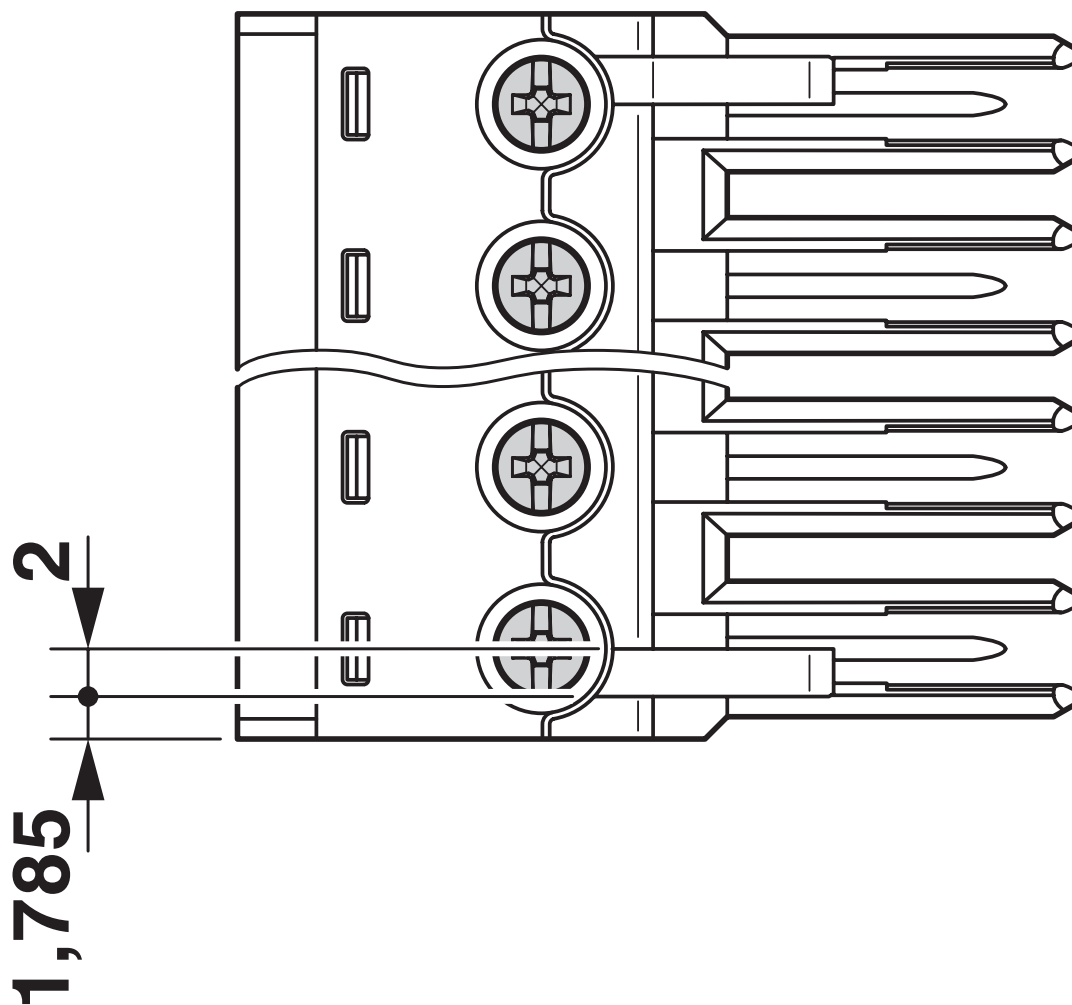

1777817

<https://www.phoenixcontact.com/us/products/1777817>



Type: PC 5/...-ST1-7,62 with PC 5/...-G-7,62  
 Conductor cross-section: 6 mm<sup>2</sup>



Type: PC 5/...-ST1-7,62 with PC 5/...-G-7,62  
 Conductor cross-section: 10 mm<sup>2</sup>

1777817

<https://www.phoenixcontact.com/us/products/1777817>



Type: PC 5/...-ST1-7,62 with PC 4/...-G-7,62  
 Conductor cross-section: 4 mm<sup>2</sup>



Type: PC 5/...-ST1-7,62 with PC 4/...-G-7,62  
 Conductor cross-section: 6 mm<sup>2</sup>

1777817

<https://www.phoenixcontact.com/us/products/1777817>

Diagram

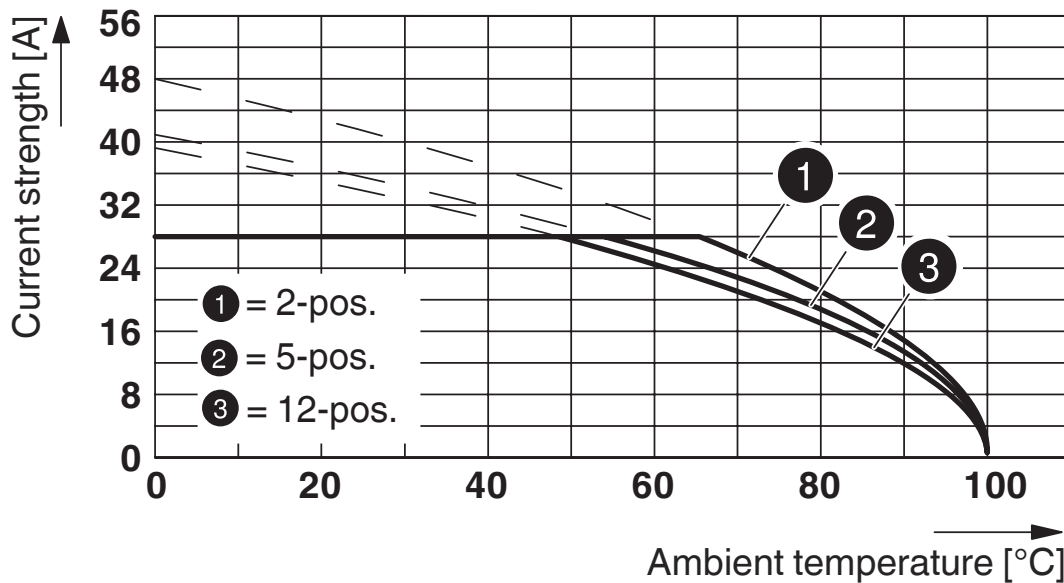

Type: PC 5/...-ST1-7,62 with PCV 4/....-G-7,62  
 Conductor cross-section: 4 mm<sup>2</sup>

Diagram



Type: PC 5/...-ST1-7,62 with PCV 4/....-G-7,62  
 Conductor cross-section: 6 mm<sup>2</sup>

1777817

<https://www.phoenixcontact.com/us/products/1777817>

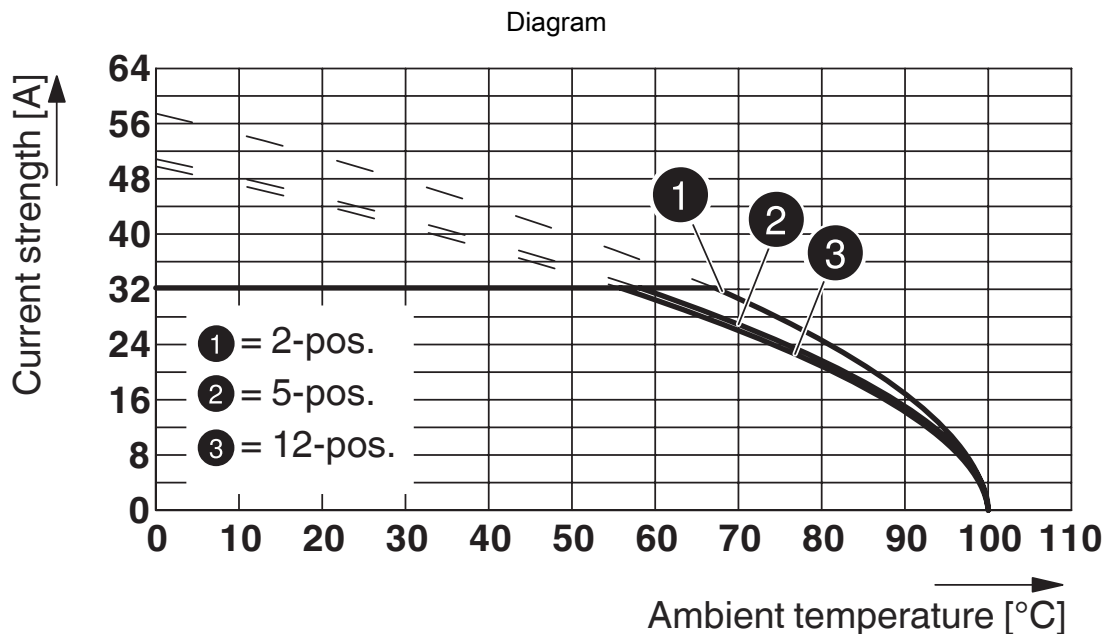

Type: PC 5/...-ST(F)1-7,62 with PC 5/...-GU(F)-7,62

Conductor cross-section: 6 mm<sup>2</sup>



Type: PC 5/...-ST(F)1-7,62 with PC 5/...-G(F)U-7,62

Conductor cross-section: 10 mm<sup>2</sup>

1777817

<https://www.phoenixcontact.com/us/products/1777817>



Type: PC 5/...-ST1-7,62 with PCV 5/...-G-7,62  
 Conductor cross-section: 6 mm<sup>2</sup>

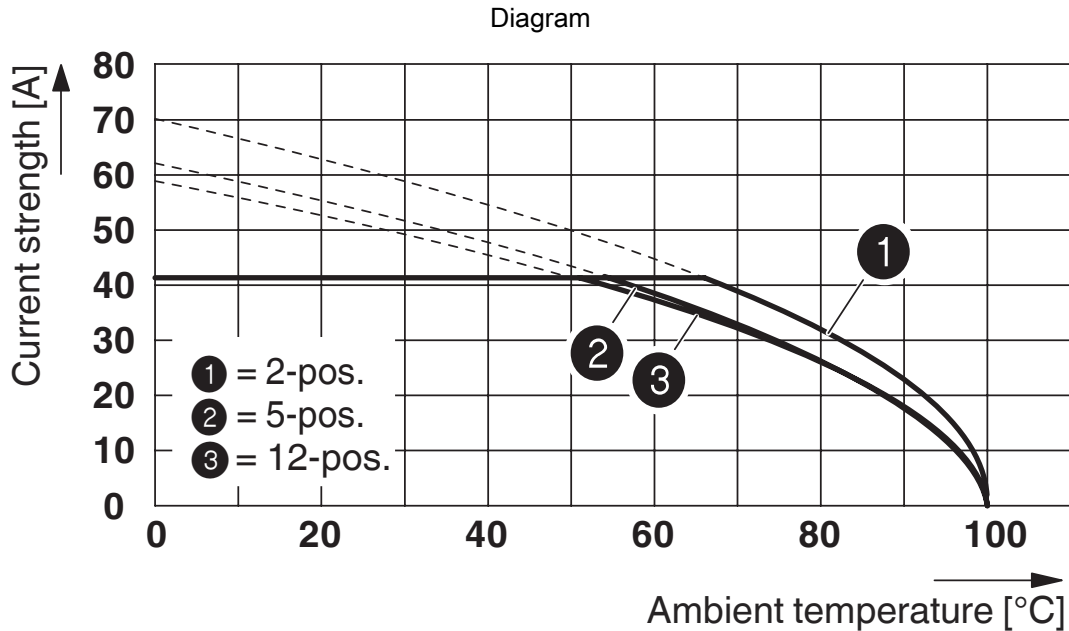

Type: PC 5/...-ST1-7,62 with PCV 5/...-G-7,62  
 Conductor cross-section: 10 mm<sup>2</sup>

1777817

<https://www.phoenixcontact.com/us/products/1777817>

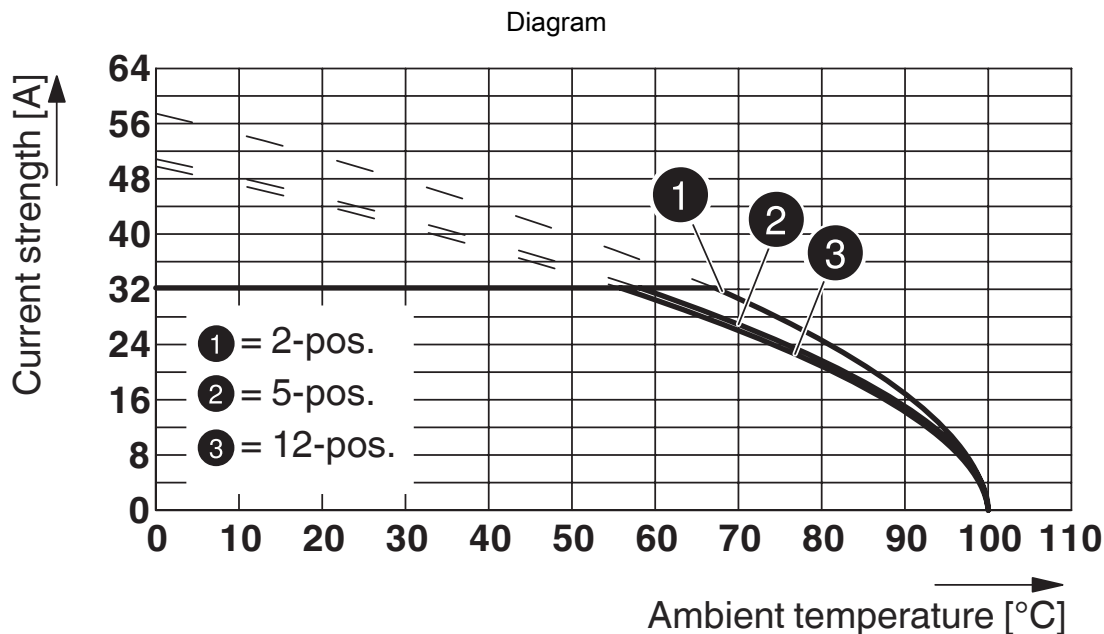

Type: PC 5/...-ST1-7,62 with PC 5/...-GU-7,62 P26 THT R..  
 Conductor cross-section: 6 mm<sup>2</sup>

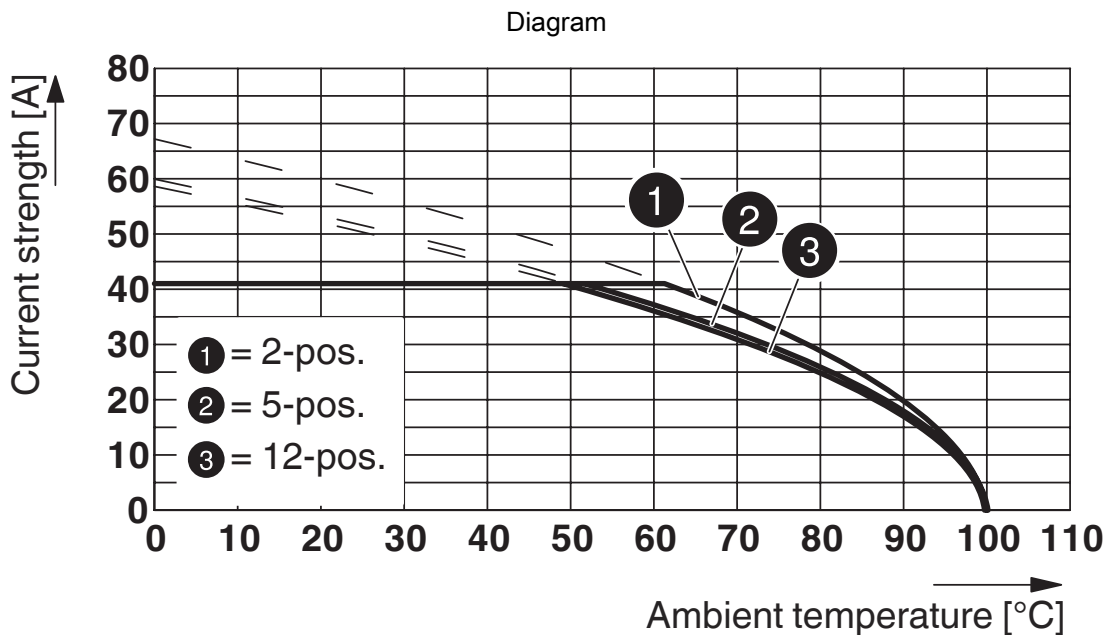

Type: PC 5/...-ST1-7,62 with PC 5/...-GU-7,62 P26 THT R..  
 Conductor cross-section: 10 mm<sup>2</sup>

1777817

<https://www.phoenixcontact.com/us/products/1777817>

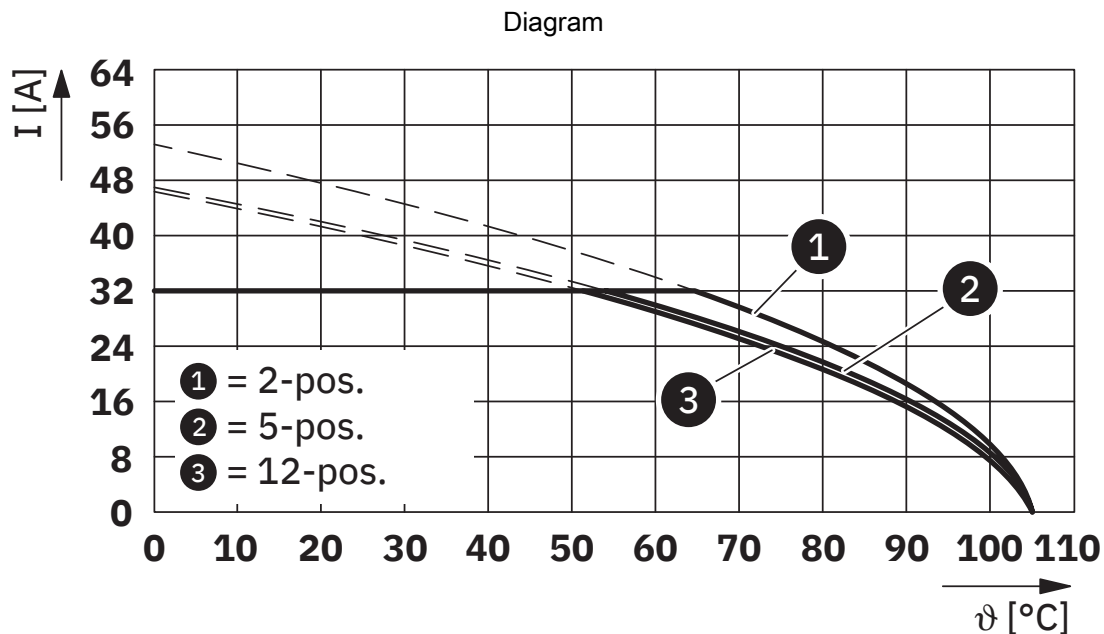

Type: PC 5/...-ST1-7,62 with IPC 5/...-ST-7,62

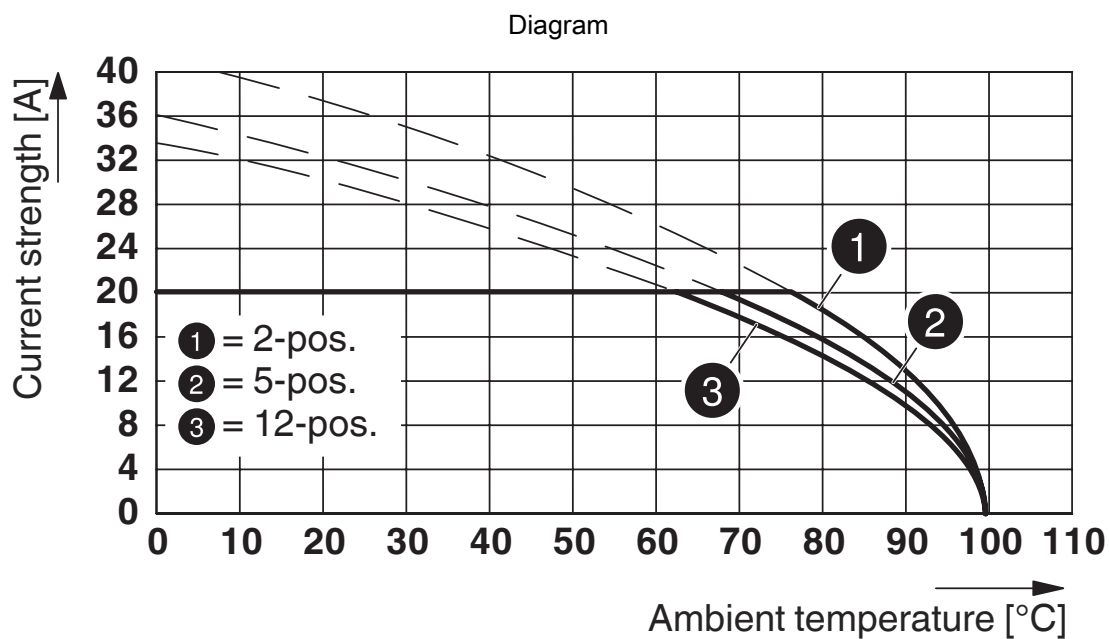

Type: PC 5/...-ST1-7,62 with PCVK 4-7,62

# PC 5/11-ST1-7,62 - PCB connector

1777817

<https://www.phoenixcontact.com/us/products/1777817>

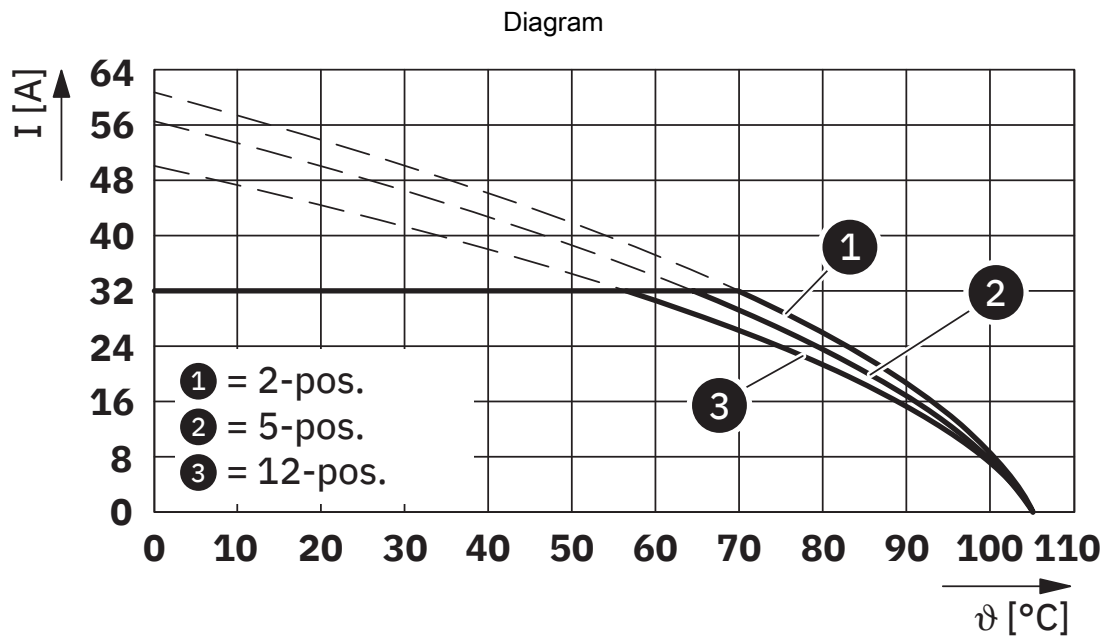

Type: PC 5/...-ST1-7,62 with DFK-PC 5/...-ST-7,62

# PC 5/11-ST1-7,62 - PCB connector



1777817

<https://www.phoenixcontact.com/us/products/1777817>

## Approvals

To download certificates, visit the product detail page: <https://www.phoenixcontact.com/us/products/1777817>

 <b>cULus Recognized</b> Approval ID: E60425-19920722		Nominal voltage $U_N$	Nominal current $I_N$	Cross section AWG	Cross section $\text{mm}^2$
<b>B</b>					
Multi-conductor connection	600 V	41 A	24 - 12	-	
Screw connection	600 V	41 A	24 - 8	-	
<b>C</b>					
Multi-conductor connection	600 V	41 A	24 - 12	-	
Screw connection	600 V	41 A	24 - 8	-	

# PC 5/11-ST1-7,62 - PCB connector



1777817

<https://www.phoenixcontact.com/us/products/1777817>

## Classifications

### ECLASS

ECLASS-13.0	27460202
ECLASS-15.0	27460202

### ETIM

ETIM 9.0	EC002638
----------	----------

### UNSPSC

UNSPSC 21.0	39121400
-------------	----------

# PC 5/11-ST1-7,62 - PCB connector



1777817

<https://www.phoenixcontact.com/us/products/1777817>

## Environmental product compliance

### EU RoHS

Fulfills EU RoHS substance requirements	Yes, No exemptions
---	--------------------

### China RoHS

Environment friendly use period (EFUP)	EFUP-E
	No hazardous substances above the limits

### EU REACH SVHC

REACH candidate substance (CAS No.)	No substance above 0.1 wt%
-------------------------------------	----------------------------

### EF3.0 Climate Change

CO2e kg	0.29 kg CO2e
---------	--------------

Phoenix Contact 2025 © - all rights reserved  
<https://www.phoenixcontact.com>

Phoenix Contact USA  
586 Fulling Mill Road  
Middletown, PA 17057, United States  
(+717) 944-1300  
[info@phoenixcon.com](mailto:info@phoenixcon.com)