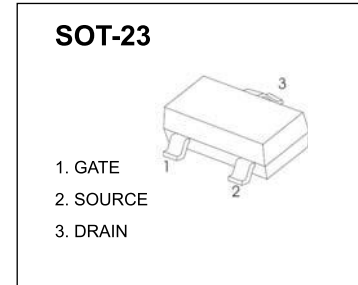

**SOT-23 Plastic-Encapsulate MOSFETS****CJ2310** N-Channel MOSFET

$V_{(BR)DSS}$	$R_{DS(on)MAX}$	I_D
60V	105mΩ@10V	3A
	125mΩ@4.5V	

**DESCRIPTION**

The CJ2310 uses advanced trench technology to provide excellent $R_{DS(ON)}$, low gate charge and operation with gate voltage as low as 2.5V. This device is suitable for use as a battery protection or in other switching application.

FEATURE

- High power and current handling capability
- Lead free product is acquired
- Surface mount package

APPLICATION

- Battery Switch
- DC/DC Converter

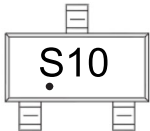
MARKING

S10= Device code

Solid dot = Green molding compound device, if none, the normal device.

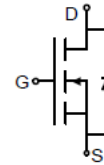
Equivalent Circuit**Maximum ratings ($T_a=25^\circ\text{C}$ unless otherwise noted)**

Parameter	Symbol	Value	Unit
Drain-Source Voltage	V_{DS}	60	V
Gate-Source Voltage	V_{GS}	± 20	V
Continuous Drain Current	I_D	3	A
Pulsed Drain Current (note 1)	I_{DM}	10	A
Power Dissipation (note 5)	P_D	3.1	W
Thermal Resistance from Junction to Ambient (note 2)	$R_{\theta JA}$	207	$^\circ\text{C/W}$
Thermal Resistance from Junction to Case (note 5)	$R_{\theta JC}$	40	$^\circ\text{C/W}$
Operation Junction and Storage Temperature Range	T_J, T_{STG}	-55~+150	$^\circ\text{C}$

MOSFET ELECTRICAL CHARACTERISTICS

$T_a=25^\circ\text{C}$ unless otherwise specified

Parameter	Symbol	Test Condition	Min	Typ	Max	Unit
STATIC CHARACTERISTICS						
Drain-source breakdown voltage	$V_{(BR)DSS}$	$V_{GS} = 0V, I_D = 250\mu A$	60			V
Zero gate voltage drain current	I_{DSS}	$V_{DS} = 60V, V_{GS} = 0V$			1	μA
Gate-body leakage current	I_{GSS}	$V_{GS} = \pm 20V, V_{DS} = 0V$			± 100	nA
Gate threshold voltage (note 3)	$V_{GS(th)}$	$V_{DS} = V_{GS}, I_D = 250\mu A$	0.5		2	V
Drain-source on-resistance (note 3)	$R_{DS(on)}$	$V_{GS} = 10V, I_D = 3A$		82	105	m Ω
		$V_{GS} = 4.5V, I_D = 3A$		91	125	m Ω
Forward transconductance (note 3)	g_{FS}	$V_{DS} = 15V, I_D = 2A$	1.4			S
Diode forward voltage (note 3)	V_{SD}	$I_S = 3A, V_{GS} = 0V$			1.2	V
DYNAMIC CHARACTERISTICS (note 4)						
Input Capacitance	C_{iss}	$V_{DS} = 30V, V_{GS} = 0V, f = 1MHz$		247		pF
Output Capacitance	C_{oss}			34		pF
Reverse Transfer Capacitance	C_{rss}			19.5		pF
SWITCHING CHARACTERISTICS (note 4)						
Turn-on delay time	$t_{d(on)}$	$V_{GS} = 10V, V_{DD} = 30V,$ $I_D = 1.5A, R_{GEN} = 1\Omega$		6		ns
Turn-on rise time	t_r			15		ns
Turn-off delay time	$t_{d(off)}$			15		ns
Turn-off fall time	t_f			10		ns
Total Gate Charge	Q_g	$V_{DS} = 30V, V_{GS} = 4.5V, I_D = 3A$		6		nC
Gate-Source Charge	Q_{gs}			1		nC
Gate-Drain Charge	Q_{gd}			1.3		nC

Notes :

1. Repetitive rating : Pulse width limited by junction temperature.
2. Mounted on 1 in² FR-4 board with 2oz. Copper, single-sided, in a still air environment with $T_A=25^\circ\text{C}$.
3. Pulse Test : Pulse Width $\leq 300\mu\text{s}$, Duty Cycle $\leq 0.5\%$.
4. Guaranteed by design, not subject to production.
5. $T_C=25^\circ\text{C}$.

Typical Characteristics

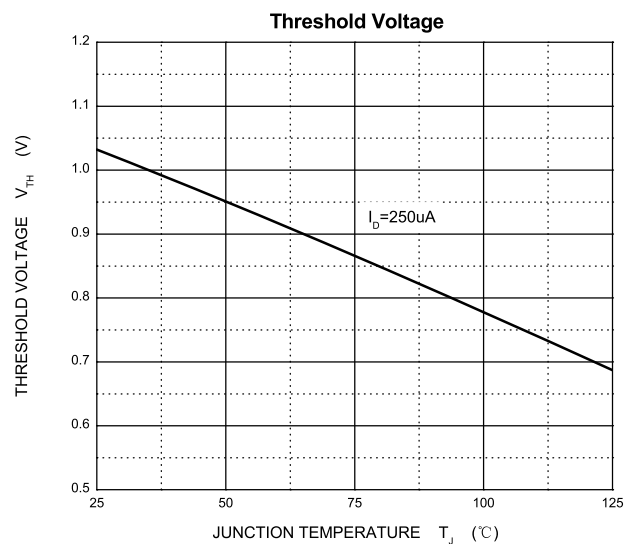
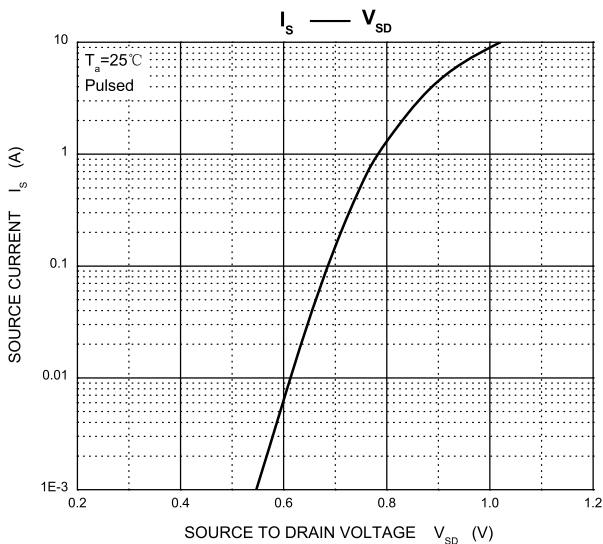
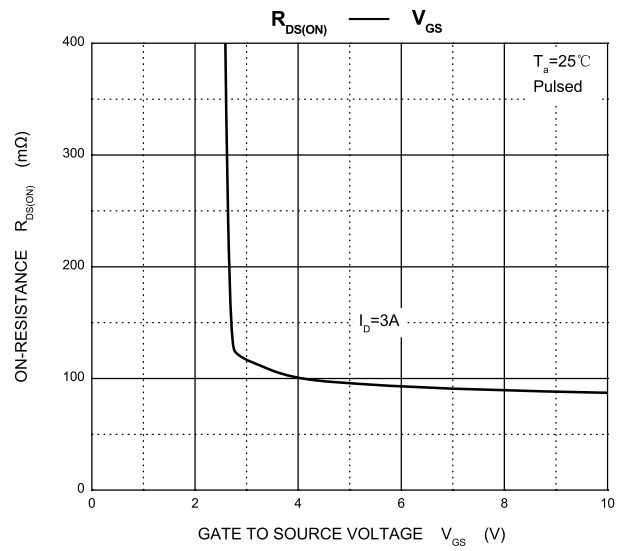
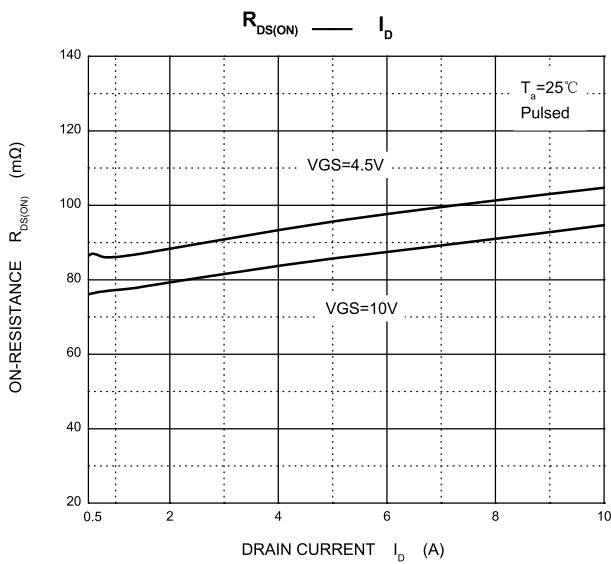
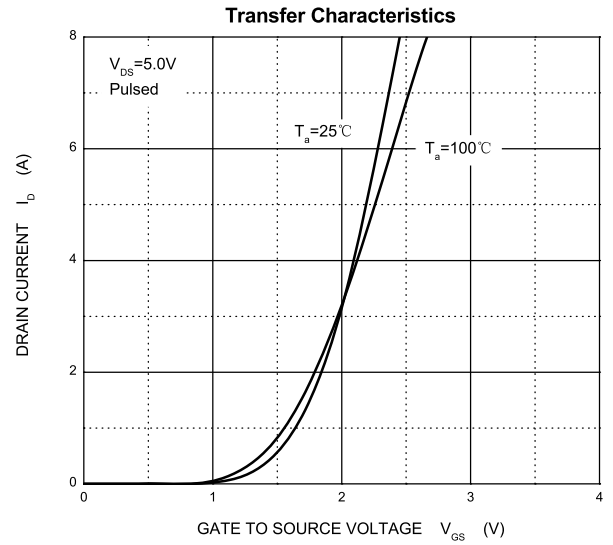
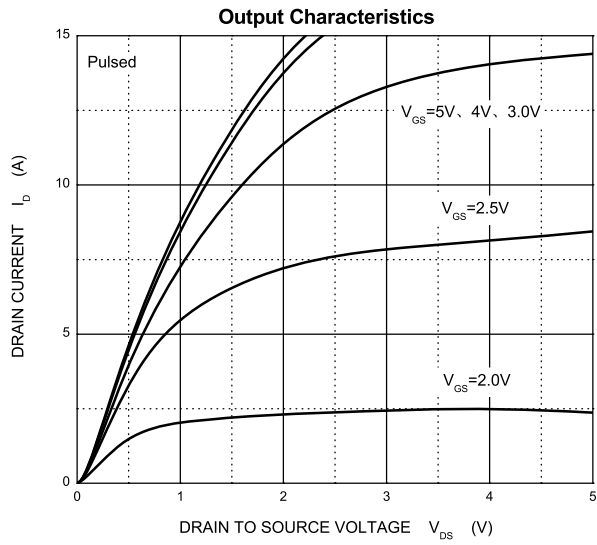

Typical Characteristics (T_J = 25°C, unless otherwise specified)

Transient Thermal Impedance, Junction-Case

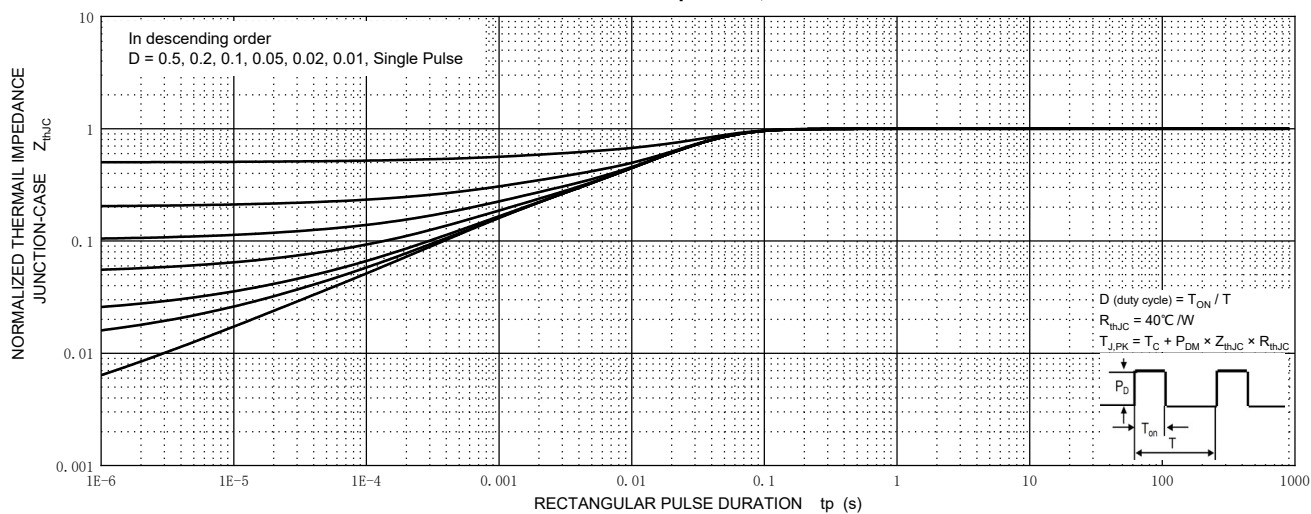

Maximum Safe Operating Area

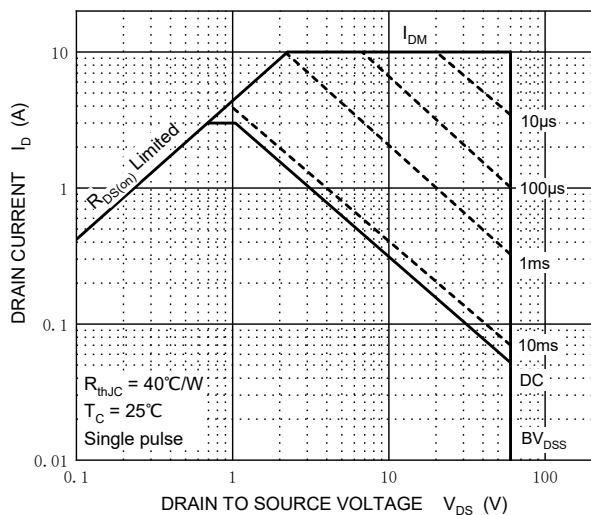

SOT-23 Package Outline Dimensions

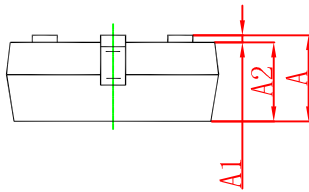
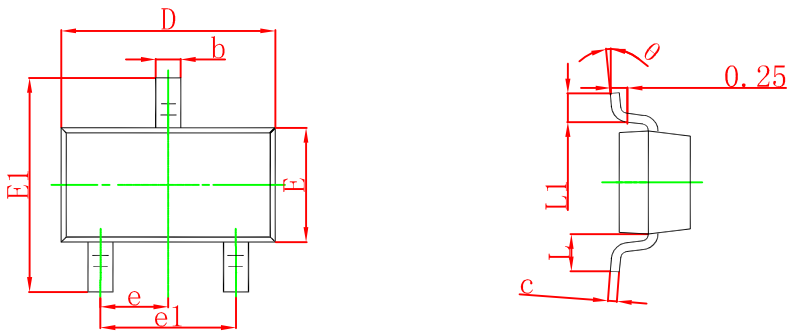

Symbol	Dimensions In Millimeters		Dimensions In Inches	
	Min	Max	Min	Max
A	0.900	1.150	0.035	0.045
A1	0.000	0.100	0.000	0.004
A2	0.900	1.050	0.035	0.041
b	0.300	0.500	0.012	0.020
c	0.080	0.150	0.003	0.006
D	2.800	3.000	0.110	0.118
E	1.200	1.400	0.047	0.055
E1	2.250	2.550	0.089	0.100
e	0.950 TYP		0.037 TYP	
e1	1.800	2.000	0.071	0.079
L	0.550 REF		0.022 REF	
L1	0.300	0.500	0.012	0.020
θ	0°	8°	0°	8°

SOT-23 Suggested Pad Layout

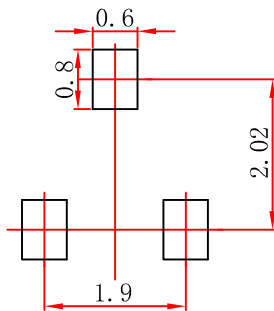

Note:

1. Controlling dimension: in millimeters.
2. General tolerance: $\pm 0.05\text{mm}$.
3. The pad layout is for reference purposes only.

NOTICE

JSCJ reserves the right to make modifications, enhancements, improvements, corrections or other changes without further notice to any product herein. JSCJ does not assume any liability arising out of the application or use of any product described herein.

SOT-23 Tape and Reel

SOT-23 Embossed Carrier Tape

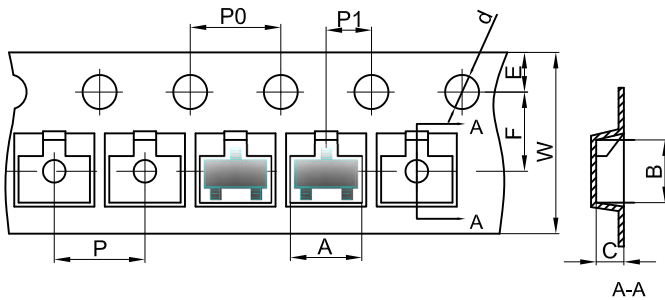

Packaging Description:

SOT-23 parts are shipped in tape. The carrier tape is made from a dissipative (carbon filled) polycarbonate resin. The cover tape is a multilayer film (Heat Activated Adhesive in nature) primarily composed of polyester film, adhesive layer, sealant, and anti-static sprayed agent. These reeled parts in standard option are shipped with 3,000 units per 7" or 17,8cm diameter reel. The reels are clear in color and is made of polystyrene plastic (anti-static coated).

Dimensions are in millimeter

Pkg type	A	B	C	d	E	F	P0	P	P1	W
SOT-23	3.15	2.77	1.22	Ø1.50	1.75	3.50	4.00	4.00	2.00	8.00

SOT-23 Tape Leader and Trailer

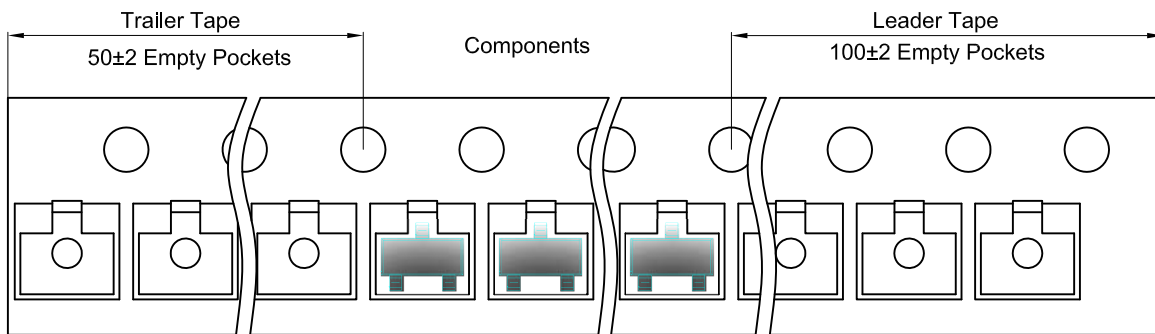

SOT-23 Reel

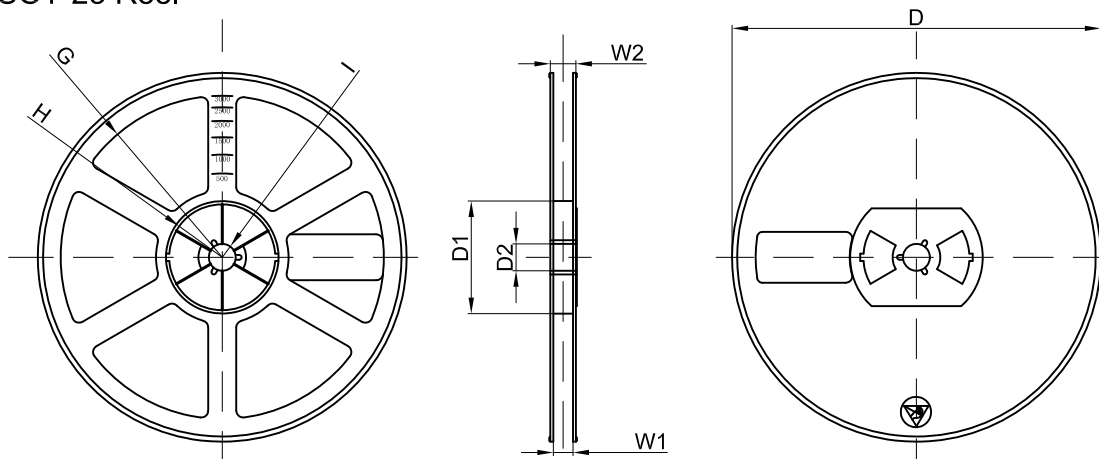

Dimensions are in millimeter

Reel Option	D	D1	D2	G	H	I	W1	W2
7"Dia	Ø178.00	54.40	13.00	R78.00	R25.60	R6.50	9.50	12.30

REEL	Reel Size	Box	Box Size(mm)	Carton	Carton Size(mm)	G.W.(kg)
3000 pcs	7 inch	30,000 pcs	203×203×195	120,000 pcs	438×438×220	