



RP8100 SERIES PUSHBUTTON SWITCH



SPECIFICATIONS

Contact Arrangement: SPST, Off-(On), Momentary
Contact Rating: 125mA @125VAC Max., 100mA @50VDC Max.
Contact Resistance: 50mΩ Max.
Insulation Resistance: 1,000MΩ @500VDC
Dielectric Strength: 1,000VAC rms
Electrical/Mechanical Life: 500,000 cycles at full load
Operating Temperature: -30°C to 85°
Travel: 1.5 [0.06 in]
Moisture Protection: IP67
Actuation Force: 2N-5N

FEATURES & BENEFITS

Threaded mount
500,000 life expectancy
Multiple Termination options
LED illumination options
Sealed to IP67 ratings
Molded back w/ wired leads (500mm long) optional

PART NUMBER CONFIGURATOR

Series



RP8100
RP8101*

Bushing



B1 - Snap in
B2 - Threaded
 (12 x 0.75)*

Termination



M1 - Solder Lug
W1 - Molded Back w/Wire
 Leads 500mm long**

Contact Material



C - Gold Over
 Silver

Seal



E - Epoxy
 Sealed

Housing Color



BLK - Black

Cap Color



WHT - White
BLK - Black
RED - Red
ORG - Orange
YEL - Yellow
GRN - Green
BLU - Blue

LED Color



NIL - Non Illuminated*
WHT - White LED
RED - Red LED
YEL - Yellow LED
GRN - Green LED
BLU - Blue LED
RG - Red/Green LED
RB - Red/Blue LED

NOTES:

*The RP8101 series (High Actuator) is only offered with B2 Bushing and is non-illuminated.
 **W1 - Molded back w/Wire Leads only available with B2 - Threaded Bushing

Specifications subject to change without notice 4/23/2026



RP8100 SERIES PUSHBUTTON SWITCH

B1 BUSHING ILLUMINATED

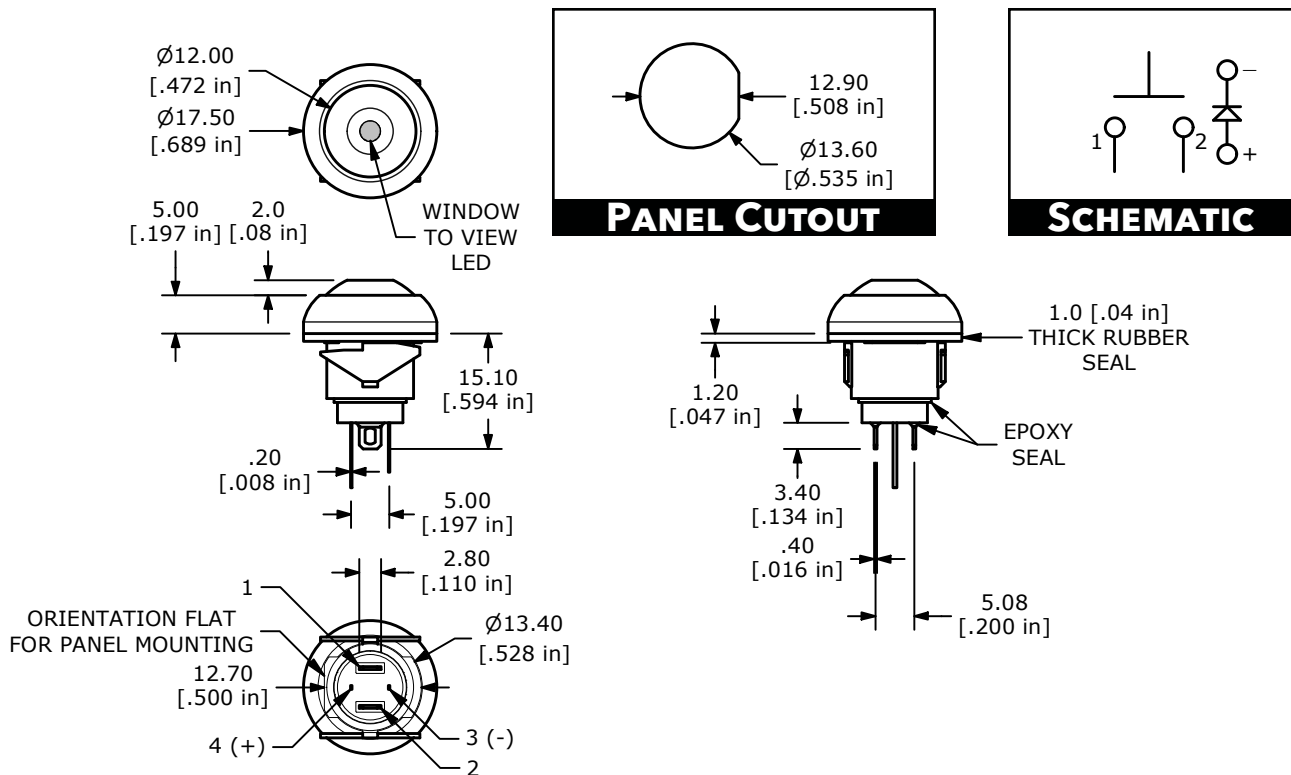

B1 BUSHING NON-ILLUMINATED

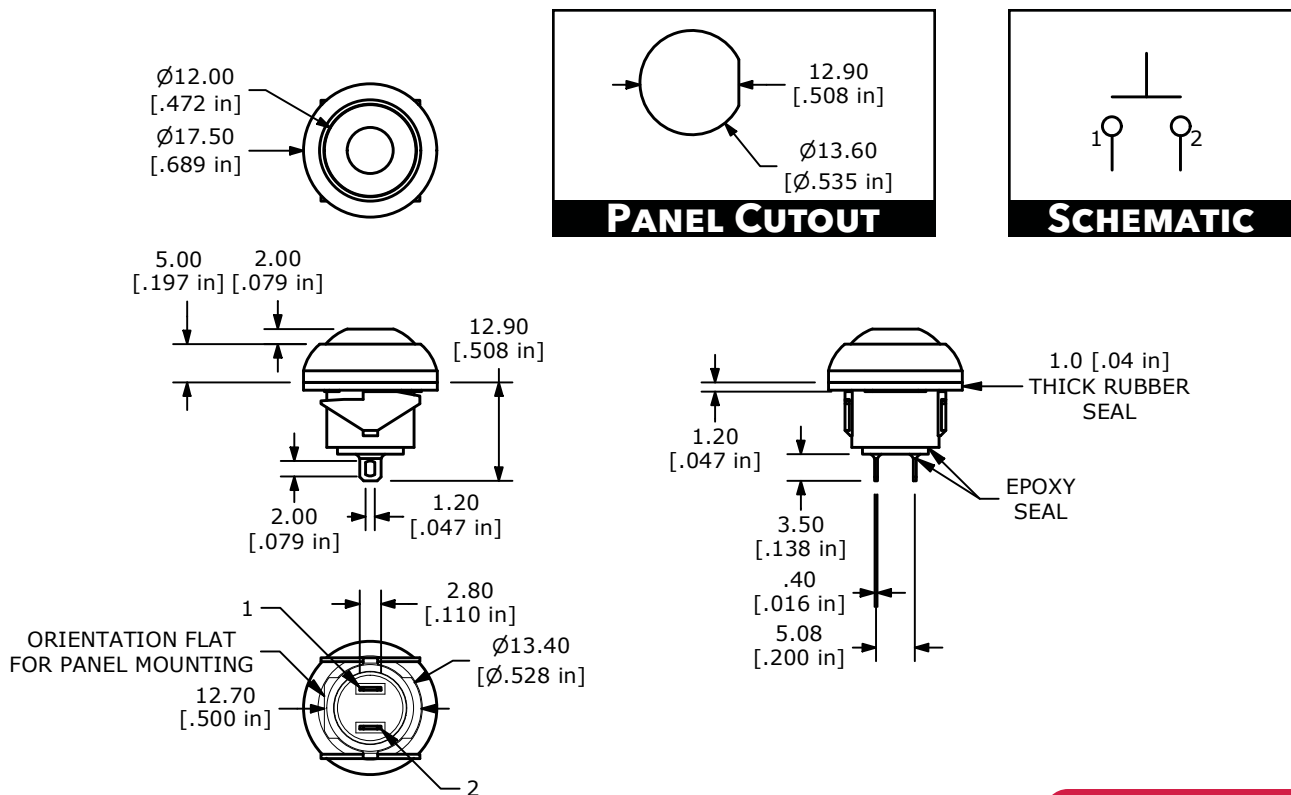



RP8100 SERIES PUSHBUTTON SWITCH

B2 BUSHING ILLUMINATED

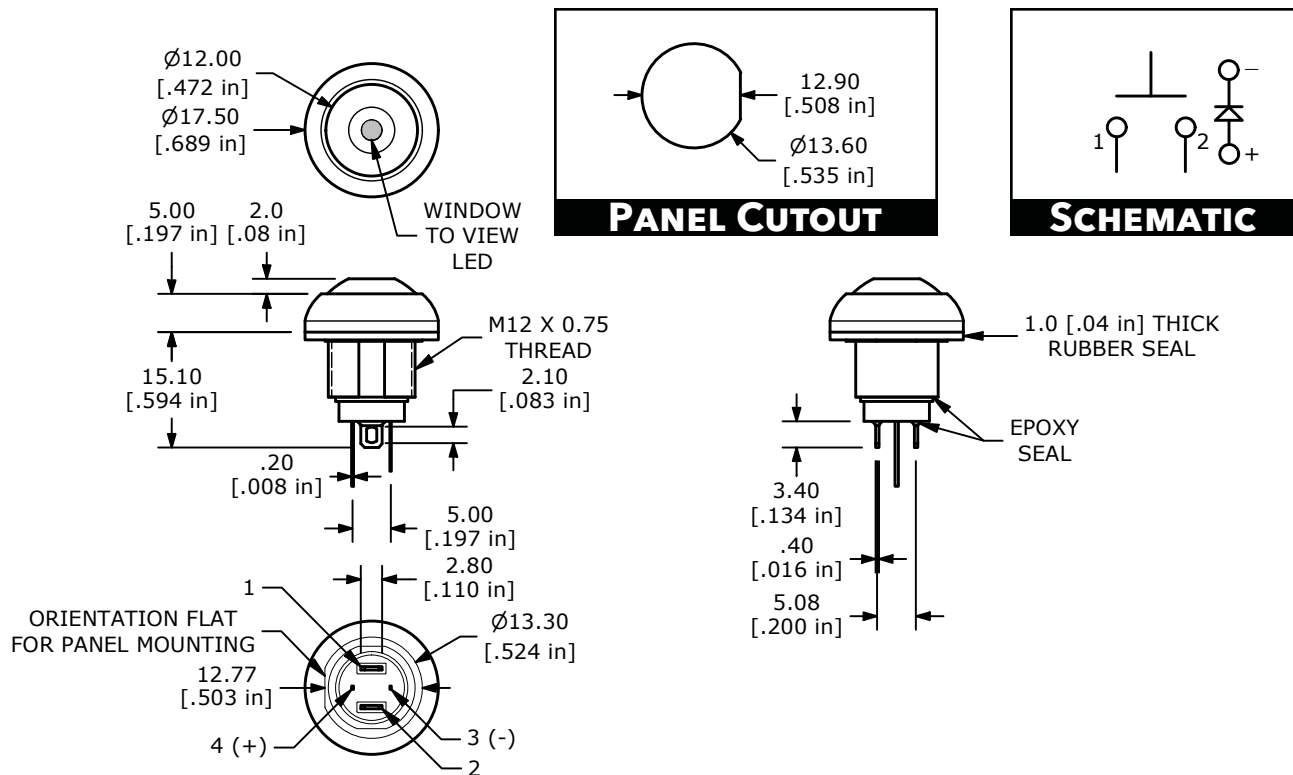

B2 BUSHING NON-ILLUMINATED

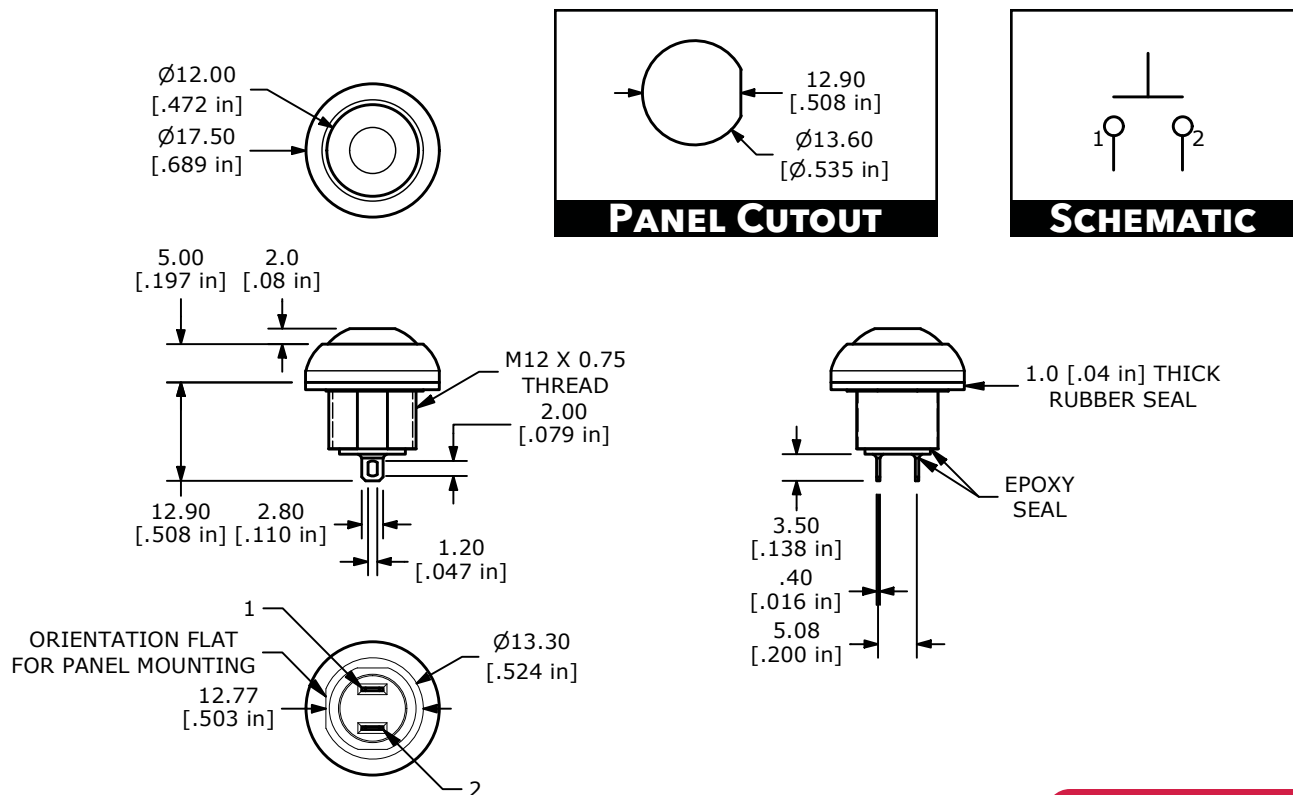



RP8100 SERIES PUSHBUTTON SWITCH

B2 ILLUMINATED MOLDED BACK WIRED LEADS

TERMINAL	WIRE
1	WIRE, 20 AWG AWM UL3385, BLACK
2	WIRE, 20 AWG AWM UL3385, BLACK
3 (-)	WIRE, 20 AWG AWM UL3385, GREEN
4 (+)	WIRE, 20 AWG AWM UL3385, RED

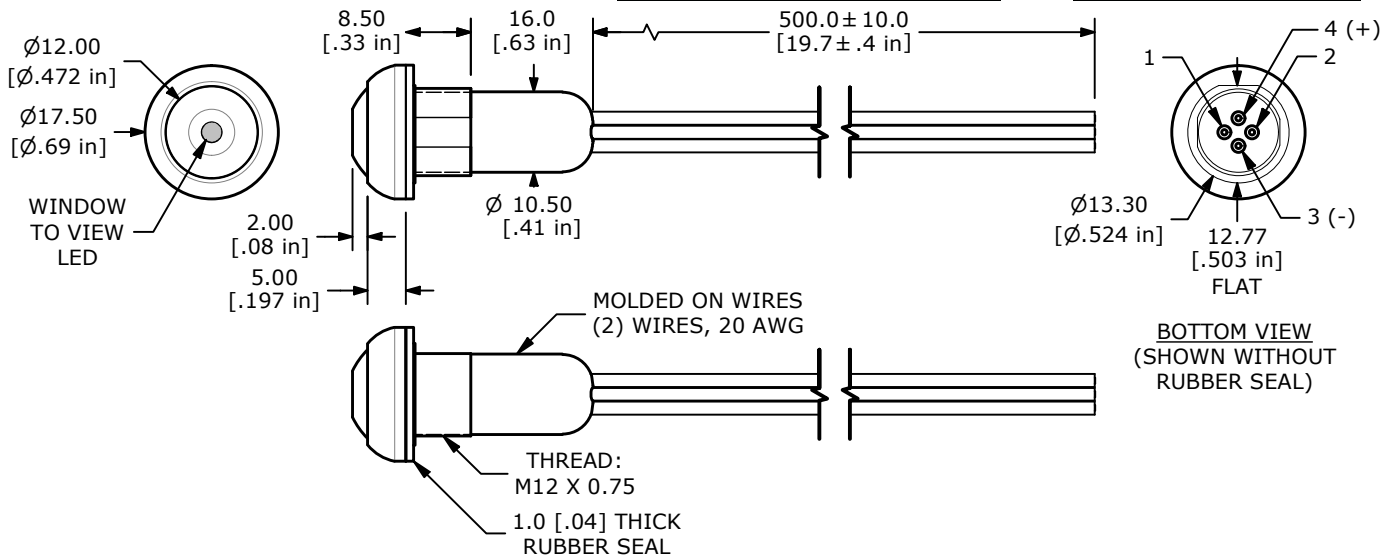
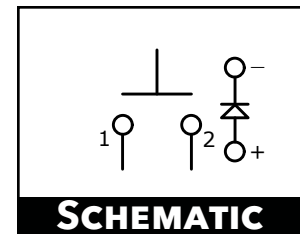
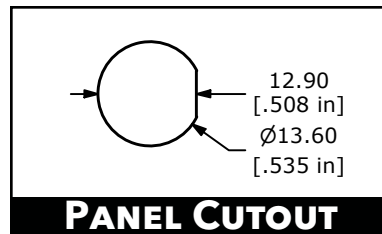

B2 NON-ILLUMINATED MOLDED BACK WIRED LEADS

TERMINAL	WIRE
1	WIRE, 20 AWG AWM UL3385, BLACK
2	WIRE, 20 AWG AWM UL3385, BLACK

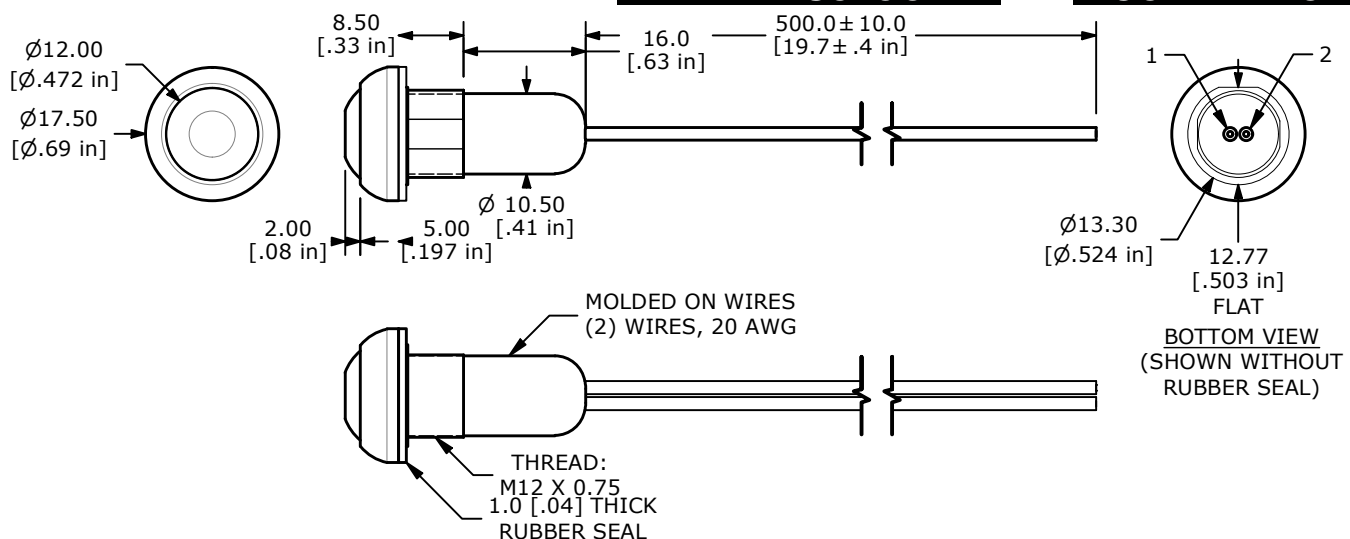
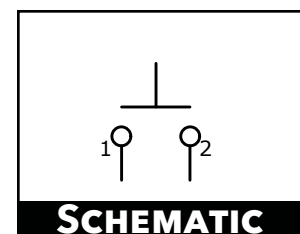
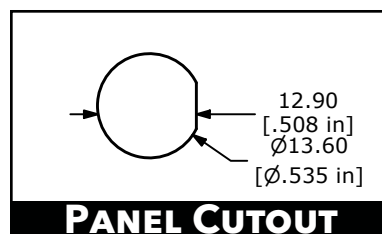



RP8100 SERIES PUSHBUTTON SWITCH

HIGH ACTUATOR B2 BUSHING NON-ILLUMINATED

