

Ultra-slim PCB Relays (EMR or SSR) 0.1 - 0.2 - 2 - 6 A



Bottling plant



Packaging machines



Labelling machines



Road / tunnel lighting



Burners, boilers and furnaces



Timers and lighting controls

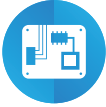

Electronic circuit boards



Programmable controllers

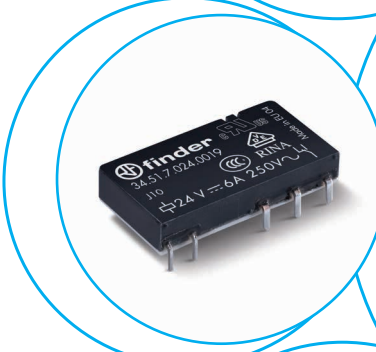

Prices, features, specifications, capabilities, appearance and availability of our products and services are subject to change without notice.
FINDER assumes no responsibility for the presence of possible errors or insufficient information in this document.
In case of discrepancies between the printed and online versions, the latter prevails.

Ultra-slim 1 Pole - 6 A relay

Printed circuit mount

- direct or via PCB socket

35 mm rail mount

- via screw, screwless or push-in terminal sockets

- 1 Pole changeover contacts or 1 Pole normally open contact
- Ultra slim (5 mm), package
- Sensitive DC coil - 170 mW (Dual AC/DC coil drive possible using 93 series sockets)
- UL Listing (certain relay/socket combinations)
- Cadmium Free contact materials
- 8/8 mm clearance/creepage distance
- 6 kV (1.2/50 μs) insulation, coil-contacts

FOR UL RATINGS SEE:

"General technical information" page V

For outline drawing see page 9

Contact specification

Contact configuration

34.51



- 5 mm wide
- Low coil power
- PCB or 93 series sockets

34.51-5010



- 5 mm wide
- Low coil power
- PCB or 93 series sockets
- Contact AgNi + Au

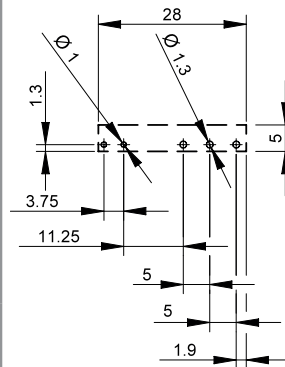
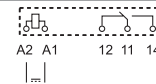
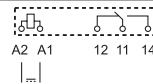

Copper side view

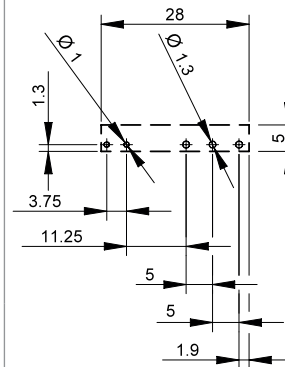

Copper side view

Rated current/ Maximum peak current	A	6/10	6/10
Rated voltage/ Maximum switching voltage	V AC	250/400	250/400
Rated load AC1	VA	1500	1500
Rated load AC15 (230 V AC)	VA	300	300
Single phase motor rating (230 V AC)	kW	0.185	0.185
Breaking capacity DC1: 24/110/220 V	A	6/0.2/0.12	6/0.2/0.12
Minimum switching load	mW (V/mA)	500 (12/10)	50 (5/2)
Standard contact material		AgNi	AgNi + Au
Coil specification			
Nominal voltage (U _N)	V AC (50/60 Hz)	—	—
	V DC	5 - 12 - 24 - 48 - 60	5 - 12 - 24 - 48 - 60
Rated power AC/DC	VA (50 Hz)/W	—/0.17	—/0.17
Operating range	AC	—	—
	DC	(0.7...1.5)U _N	(0.7...1.5)U _N
Holding voltage	AC/DC	—/0.4 U _N	—/0.4 U _N
Must drop-out voltage	AC/DC	—/0.05 U _N	—/0.05 U _N
Technical data			
Mechanical life AC/DC	cycles	—/10 · 10 ⁶	—/10 · 10 ⁶
Electrical life at rated load AC1	cycles	60 · 10 ³	60 · 10 ³
Operate/release time	ms	5/3	5/3
Insulation between coil and contacts (1.2/50 μs)	kV	6 (8 mm)	6 (8 mm)
Dielectric strength between open contacts	V AC	1000	1000
Ambient temperature range	°C	-40...+85	-40...+85
Environmental protection		RT II	RT II
Approvals (according to type)			

Ultra-slim Solid State Relays

Printed circuit mount

- direct or via PCB socket

35 mm rail mount

- via screw, screwless or push-in terminal sockets

- Single circuit output switching options
 - 6 A, 24 V DC
 - 2 A, 240 V AC
- Silent, high speed switching with long electrical life
- Ultra slim (5 mm), package
- Sensitive DC Input circuits (Dual AC/DC input drive possible using 93 series sockets)
- UL Listing (certain relay/socket combinations)
- Wash tight: RT III
- 3000 V AC insulation, input-output

NEW 34.81.7.xxx.9024



- 6 A, 24 V DC output switching
- PCB or 93 series sockets

34.81.7.xxx.8240



- 2 A, 240 V AC output switching
- Zero crossing switching
- PCB or 93 series sockets

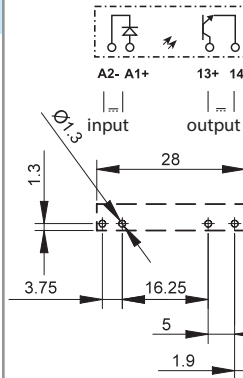

Copper side view

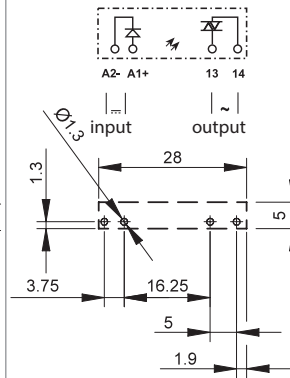

Copper side view

For outline drawing see page 9

Output circuit

Contact configuration		1 NO (SPST-NO)	1 NO (SPST-NO)
Rated current/ Maximum peak current (10 ms)	A	6/50	2/80
Rated switching voltage	V	24 DC	240 AC (50/60 Hz)
Switching voltage range	V	(1.5...33)DC	(12...275)AC
Maximum blocking voltage	V	33	—
Repetitive peak off-state voltage	V _{pk}	—	800
Rated load DC13	W	36	—
Rated load AC15	VA	—	300
Minimum switching current	mA	1	35
Max. "OFF-state" leakage current	mA	0.001	1.5
Max. "ON-state" voltage drop	V	0.4	1.6

Supply specification

Nominal voltage (U _N)	V DC	5	12	24	60	5	12	24	60
Rated power	W	0.035	0.085	0.17	0.21	0.06	0.085	0.17	0.21
Operating range	V DC	35...12	8...17	16...30	35...72	35...10	8...17	16...30	35...72
Control current	mA	7	7	7	3.5	12	7	7	3.5
Release voltage	V DC	4	4	10	20	1	4	10	20

Technical data

Electrical life at rated load	cycles	> 10 ⁶				> 10 ⁶			
Operate/release time	ms	0.02/0.2				11/11			
Insulation between input and output (1.2/50μs)	kV	4				4			
Ambient temperature range	°C	-20...+70*				-20...+50*			
Environmental protection		RT III				RT III			

Approvals (according to type)



* Note: all technical data relates to using the relay directly on PCB or PCB socket type 93.11. If the relay is used with 35 mm rail socket types 93.01 and 93.51, refer to the technical data of 38 Series; if used with types 93.60, 93.61, 93.62, 93.63, 93.64, 93.65, 93.66, 93.67, 93.68 and 93.69, refer to the technical data of the MasterINTERFACE 39 Series. See L34 diagrams page 8

Ultra-slim Solid State Relays

Printed circuit mount

- direct or via PCB socket

35 mm rail mount

- via screw, screwless or push-in terminal sockets

- Single circuit output switching options
 - 0.1 A, 48 V DC
 - 0.2 A, 220 V DC
- Silent, high speed switching with long electrical life
- Ultra slim (5 mm), package
- Sensitive DC Input circuits (Dual AC/DC input drive possible using 93 series sockets)
- UL Listing (certain relay/socket combinations)
- Wash tight: RT III
- 3000 V AC insulation, input-output

34.81.7.xxx.7048

NEW

34.81.7.xxx.7220



- 100 mA, 48 V DC output switching
- PCB or 93 series sockets

- 200 mA, 110/220 V DC output switching
- PCB or 93 series sockets

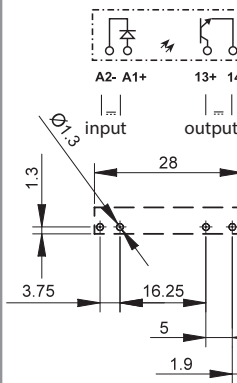

Copper side view

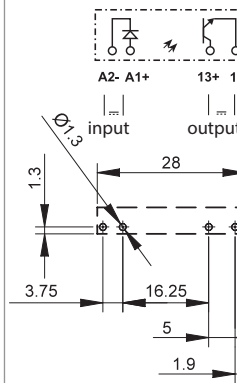

Copper side view

For outline drawing see page 9

Output circuit

Contact configuration		1 NO (SPST-NO)	1 NO (SPST-NO)
Rated current/ Maximum peak current (10 ms)	A	0.1/0.5	0.2/10
Rated switching voltage	V	48 DC	220 DC
Switching voltage range	V	(1.5...53)DC	(90...256)DC
Maximum blocking voltage	V	53	256
Rated load DC13	W	2.4	44
Minimum switching current	mA	0.05	0.05
Max. "OFF-state" leakage current	mA	0.001	0.001
Max. "ON-state" voltage drop	V	1	0.4

Supply specification

Nominal voltage (U _N)	V DC	24	60	24	60
Rated power	W	0.17	0.21	0.17	0.21
Operating range	V DC	16...30	35...72	16...30	35...72
Control current	mA	7	3.5	7	3.5
Release voltage	V DC	10	20	10	20

Technical data

Electrical life at rated load	cycles	> 10 ⁶	> 10 ⁶
Operate/release time	ms	0.03/0.6	0.4/2.2
Insulation between input and output (1.2/50μs)	kV	4	4
Ambient temperature range	°C	-20...+70*	-20...+70*
Environmental protection		RT III	RT III

Approvals (according to type)



* Note: all technical data relates to using the relay directly on PCB or PCB socket type 93.11.
If the relay is used with 35 mm rail socket types 93.01 and 93.51, refer to the technical data of 38 Series; if used with types 93.60, 93.61, 93.62, 93.63, 93.64, 93.65, 93.66, 93.67, 93.68 and 93.69, refer to the technical data of the MasterINTERFACE 39 Series.

Ordering information

Electromechanical relay (EMR)

Example: 34 series Ultra-Slim electromechanical relay, 1 CO (SPDT) 6 A contacts, 24 V sensitive DC coil.

A

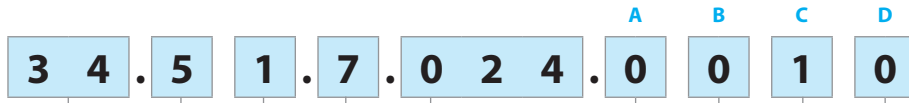

Series
34 = 34 series

Type
5 = Electromechanical type

No. of poles
1 = 1 pole, 6 A

Coil version
7 = Sensitive DC

Coil voltage
See coil specifications

A: Contact material
0 = Standard AgNi
4 = AgSnO₂
5 = AgNi + Au

B: Contact circuit
0 = CO (SPDT)
3 = NO (SPST)

D: Special versions
0 = Flux proof (RT II)
9 = Flat version

C: Options
1 = None

Selecting features and options: only combinations in the same row are possible.

Preferred selections for best availability are shown in **bold**.

Type	Coil version	A	B	C	D
34.51	sens. DC	0 - 4 - 5	0 - 3	1	0
34.51	sens. DC	0 - 4 - 5	0	1	9

Solid state relay (SSR)

Example: 34 series solid state relay, 6 A 24 V DC output, 24 V DC supply.



Series
34 = 34 series

Type
8 = SSR type

Output
1 = 1 NO (SPST-NO)

Input circuit
See input specifications

Output circuit
9024 = 6 A - 24 V DC
7048 = 0.1 A - 48 V DC
7220 = 0.2 A - 220 V DC
8240 = 2 A - 240 V AC

Flat pack version



Option = 34.51.7xxx.x019

Environmental protection RT I

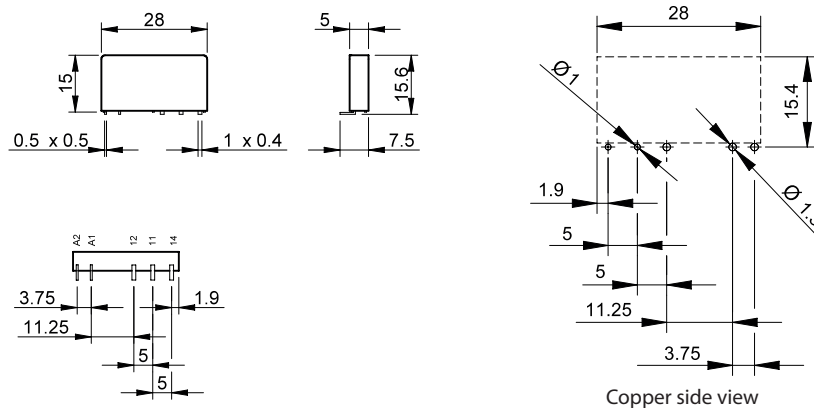

Electromechanical relay

A

Technical data

Insulation according to EN 61810-1			
Nominal voltage of supply system	V AC	230/400	
Rated insulation voltage	V AC	250	400
Pollution degree		3	2
Insulation between coil and contact set			
Type of insulation		Reinforced	
Overvoltage category		III	
Rated impulse voltage	kV (1.2/50 μ s)	6	
Dielectric strength	V AC	4000	
Insulation between open contacts			
Type of disconnection		Micro-disconnection	
Dielectric strength	V AC/kV (1.2/50 μ s)	1000/1.5	
Insulation between coil terminals			
Rated impulse voltage (surge) differential mode (according to EN 61000-4-5)	kV (1.2/50 μ s)	2	
Other data			
Bounce time: NO/NC	ms	1/6	
Vibration resistance (5...55)Hz: NO/NC	g	10/5	
Shock resistance	g	20/14	
Power lost to the environment	without contact current	W	0.2
	with rated current	W	0.5
Recommended distance between relays mounted on PCB	mm	≥ 5	

Contact specification

F 34 - Electrical life (AC) v contact current

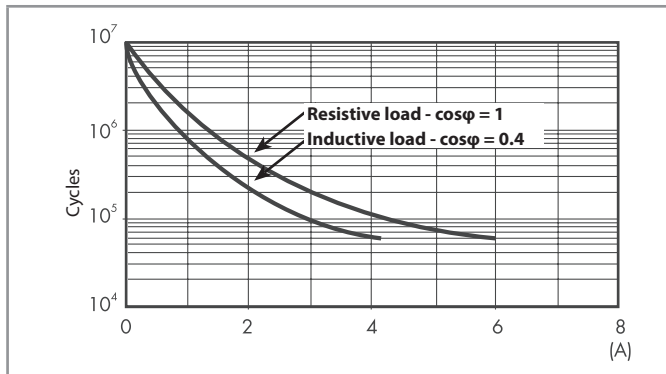

H 34 - Maximum DC1 breaking capacity

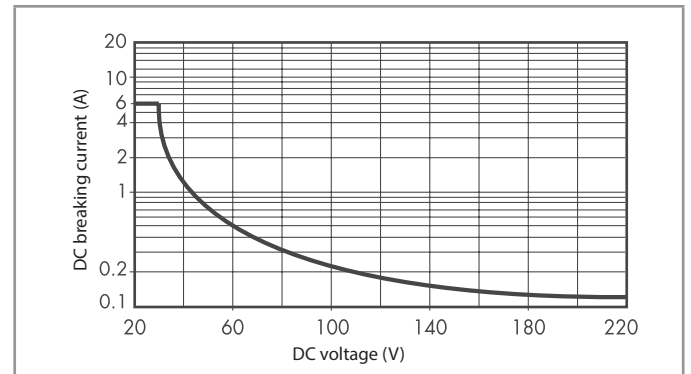

- When switching a resistive load (DC1) having voltage and current values under the curve, an electrical life of $\geq 60 \cdot 10^3$ can be expected.
- In the case of DC13 loads, the connection of a diode in parallel with the load will permit a similar electrical life as for a DC1 load.
Note: the release time for the load will be increased.

Coil specifications

DC coil data

Nominal voltage	Coil code	Operating range		Resistance	Rated coil consumption
		U_{min}	U_{max}		
V		V	V	Ω	mA
5	7.005	3.5	7.5	130	38.4
12	7.012	8.4	18	840	14.2
24	7.024	16.8	36	3350	7.1
48	7.048	33.6	72	12300	3.9
60	7.060	42	90	19700	3

R 34 - DC coil operating range v ambient temperature

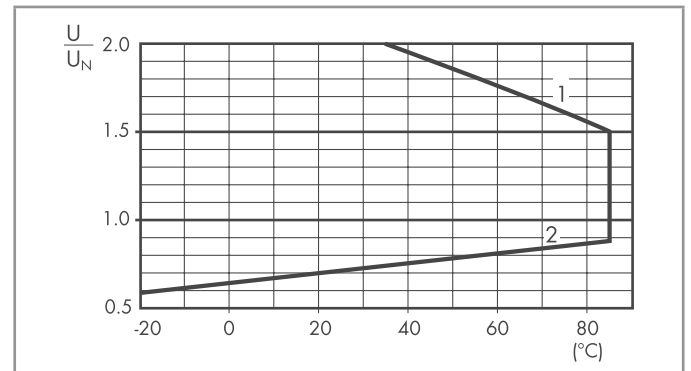

- 1 - Max. permitted coil voltage.
- 2 - Min. pick-up voltage with coil at ambient temperature.

Solid state relay

Technical data

A

Insulation		Dielectric strength	Impulse (1.2/50 µs)
Between input and output		3000 V AC	4 kV
EMC specifications		Reference standard	
Electrostatic discharge	contact discharge	EN 61000-4-2	4 kV
	air discharge	EN 61000-4-2	8 kV
Radiated electromagnetic field (80...1000 MHz)		EN 61000-4-3	10 V/m
Fast transients on supply terminals (burst 5/50 ns, 5 and 100 kHz)		EN 61000-4-4	2 kV
Voltage pulses on supply terminals (surge 1.2/50 µs)	common mode	EN 61000-4-5	0.7 kV
	differential mode	EN 61000-4-5	0.7 kV*
Radio-frequency common mode voltage (0.15...230 MHz)		EN 61000-4-6	10 V
Other data			
Power lost to the environment	without output current	W	0.15
	with rated current	W	0.4

* For 34.81.7.005... = 0.3 kV; for 34.81.7.012... = 0.5 kV

Input specification

Input data - DC types

Nominal voltage U_N V	Input code	Operating range		Release voltage V	Impedance Ω	Control current I at U_N mA
		U_{min} V	U_{max} V			
5	7.005	3.5	12*	1	715	7*
12	7.012	8	17	4	1715	7
24	7.024	16	30	10	3430	7
60	7.060	35	72	20	17000	3.5

* For 34.81.7.005.8240: $U_{MAX} = 10 V$, I @ 5 V = 12 mA

Output specification

L 34-1 - Output DC current v ambient temperature

34.81.7...9024

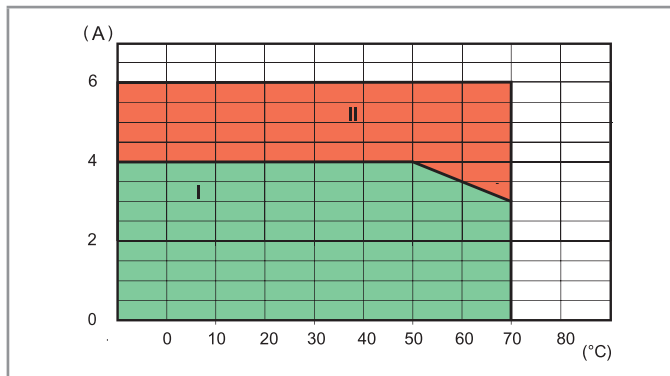

L 34 - Output AC current v ambient temperature

34.81.7...8240

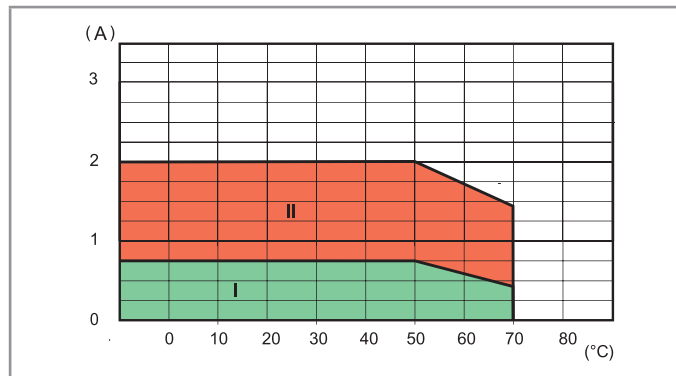

I: SSR installed on 93 series sockets as a group (without gap between sockets)

II: SSR installed individually in free air, or with a gap ≥ 9 mm, which implies a not significant influence from nearby components

Max recommended switching frequency (Cycles/Hour, with 50% Duty-cycle) at ambient temperature 50°C, single mounting

Load	34.81.7xxx.9024	34.81.7xxx.8240	34.81.7xxx.7048	34.81.7xxx.7220
24 V 6 A DC1	180 000	—	—	—
24 V 3 A DC L/R = 10 ms	5000	—	—	—
24 V 2 A DC L/R = 40 ms	3600	—	—	—
24 V 1 A DC L/R = 40 ms	6500	—	—	—
24 V 0.8 A DC L/R = 40 ms	9000	—	—	—
24 V 1.5 A DC L/R = 80 ms	3250	—	—	—
230 V 2 A AC1	—	60 000	—	—
230 V 1.25 A AC15	—	3600	—	—
48 V 0.1 A DC1	—	—	60 000	—
220 V 0.2 A DC1	—	—	—	60 000

Outline drawings

Type 34.51

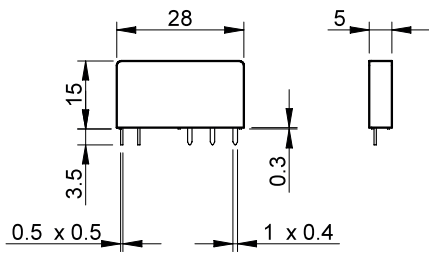

Type 34.81

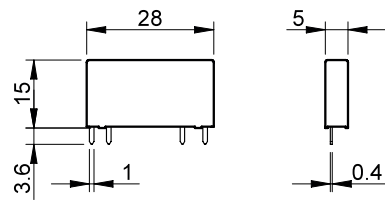

A

A

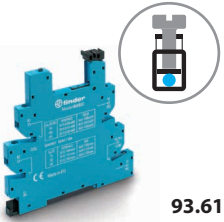

93.61

Screw terminal socket 35 mm rail mounting (EN 60715)

Common features

- Space saving 6.2 mm wide
- Connections for 16-way jumper link
- Integral coil indication and protection circuit
- Secure retention and easy ejection by plastic clip
- Dual screw head (blade+cross) terminals

For technical data and supply versions, refer to the Master **INTERFACE 39 Series** – “Relay interface module”

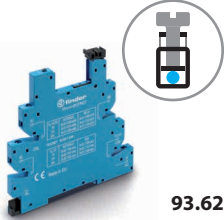

93.62

Electromechanical Relay - EMR

Supply voltage	Relay type	Socket type (reference with the 39 Series)				
		Master BASIC (39.11.....)	Master PLUS (39.31.....)	Master INPUT (39.41.....)	Master OUTPUT (39.21.....)	Master TIMER (39.81.....)
6 V AC/DC	34.51.7.005.xx10	93.61.7.024	93.63.7.024	93.64.7.024	93.62.7.024	—
12 V AC/DC	34.51.7.012.xx10	93.61.7.024	93.63.7.024	93.64.7.024	93.62.7.024	93.68.0.024
24 V AC/DC	34.51.7.024.xx10	93.61.7.024	93.63.7.024	93.64.7.024	93.62.7.024	93.68.0.024
60 V AC/DC	34.51.7.060.xx10	—	93.63.7.060	—	—	—
(110...125)V AC/DC*	34.51.7.060.xx10	—	93.63.3.125	—	—	—
(220...240)V AC*	34.51.7.060.xx10	—	93.63.3.230	—	—	—
(110...125)V AC/DC	34.51.7.060.xx10	93.61.0.125	93.63.0.125	93.64.0.125	93.62.0.125	—
(24...240)V AC/DC	34.51.7.024.xx10	—	93.63.0.240	—	—	—
(220...240)V AC	34.51.7.060.xx10	93.61.8.230	93.63.8.230	93.64.8.230	93.62.8.230	—
(110...125)V DC	34.51.7.060.xx10	—	93.63.7.125	—	—	—
220 V DC	34.51.7.060.xx10	—	93.63.7.220	—	—	—

* Leakage current suppression

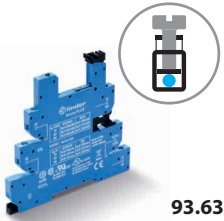

93.63

Solid State Relay - SSR

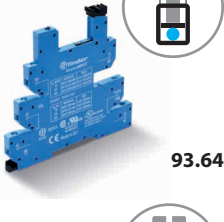

93.64

Supply voltage	Relay type	Socket type (reference with the 39 Series)				
		Master BASIC (39.10.....)	Master PLUS (39.30.....)	Master INPUT (39.40.....)	Master OUTPUT (39.20.....)	Master TIMER (39.80.....)
12 V AC/DC	34.81.7.012.xxxx	—	—	—	—	93.68.0.024
24 V AC/DC	34.81.7.024.xxxx	—	93.63.0.024	93.64.0.024	—	93.68.0.024
(110...125)V AC/DC*	34.81.7.060.xxxx	—	93.63.3.125	—	—	—
(220...240)V AC*	34.81.7.060.xxxx	—	93.63.3.230	—	—	—
(110...125)V AC/DC	34.81.7.060.xxxx	93.61.0.125	93.63.0.125	93.64.0.125	93.62.0.125	—
(24...240)V AC/DC	34.81.7.024.xxxx	—	93.63.0.240	—	—	—
(220...240)V AC	34.81.7.060.xxxx	93.61.8.230	93.63.8.230	93.64.8.230	93.62.8.230	—
6 V DC	34.81.7.005.xxxx	93.61.7.024	93.63.7.024	93.64.7.024	93.62.7.024	—
12 V DC	34.81.7.012.xxxx	93.61.7.024	93.63.7.024	93.64.7.024	93.62.7.024	—
24 V DC	34.81.7.024.xxxx	93.61.7.024	93.63.7.024	93.64.7.024	93.62.7.024	—
60 V DC	34.81.7.060.xxxx	—	93.63.7.060	—	—	—
(110...125)V DC	34.81.7.060.xxxx	—	93.63.7.125	—	—	—
220 V DC	34.81.7.060.xxxx	—	93.63.7.220	—	—	—

* Leakage current suppression

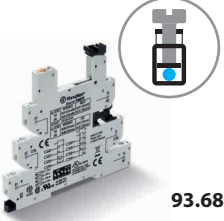

93.68

Approvals
(according to type):



Accessories

16-way jumper link	093.16 (blue), 093.16.0 (black), 093.16.1 (red)
Dual-purpose plastic separator	093.60
Sheet of marker tags	060.48 and 093.48

Technical data

Rated values	6 A - 250 V
Dielectric strength	6 kV (1.2/50 μs) between coil and contacts
Protection category	IP 20
Ambient temperature	°C -40...+70
Screw torque	Nm 0.5
Wire strip length	mm 10
Max wire size	Solid wire and stranded wire
	mm ² 1 x (0.5...2.5) / 2 x 1.5
	AWG 1 x (21...14) / 2 x 16



Push-In terminal socket 35 mm rail mounting (EN 60715)

Common features

- Space saving 6.2 mm wide
- Connections for 16-way jumper link
- Terminal doubler 093.62
- Integral coil indication and protection circuit
- Secure retention and easy ejection by plastic clip



93.60

For technical data and supply versions, refer to the Master**INTERFACE 39 Series** – “Relay interface module”



Electromechanical Relay - EMR



93.65

Supply voltage	Relay type	Socket type (reference with the 39 Series)				
		Master BASIC (39.01.....)	Master PLUS (39.61.....)	Master INPUT (39.71.....)	Master OUTPUT (39.51.....)	Master TIMER (39.91.....)
6 V AC/DC	34.51.7.005.xx10	93.60.7.024	93.66.7.024	93.67.7.024	93.65.7.024	—
12 V AC/DC	34.51.7.012.xx10	93.60.7.024	93.66.7.024	93.67.7.024	93.65.7.024	93.69.0.024
24 V AC/DC	34.51.7.024.xx10	93.60.7.024	93.66.7.024	93.67.7.024	93.65.7.024	93.69.0.024
60 V AC/DC	34.51.7.060.xx10	—	93.66.7.060	—	—	—
(110...125)V AC/DC*	34.51.7.060.xx10	—	93.66.3.125	—	—	—
(220...240)V AC*	34.51.7.060.xx10	—	93.66.3.230	—	—	—
(110...125)V AC/DC	34.51.7.060.xx10	93.60.0.125	93.66.0.125	93.67.0.125	93.65.0.125	—
(24...240)V AC/DC	34.51.7.024.xx10	—	93.66.0.240	—	—	—
(220...240)V AC	34.51.7.060.xx10	93.60.8.230	93.66.8.230	93.67.8.230	93.65.8.230	—
(110...125)V DC	34.51.7.060.xx10	—	93.66.7.125	—	—	—
220 V DC	34.51.7.060.xx10	—	93.66.7.220	—	—	—

* Leakage current suppression



93.66

Solid State Relay - SSR



93.67

Supply voltage	Relay type	Socket type (reference with the 39 Series)				
		Master BASIC (39.00.....)	Master PLUS (39.60.....)	Master INPUT (39.70.....)	Master OUTPUT (39.50.....)	Master TIMER (39.90.....)
12 V AC/DC	34.81.7.012.xxxx	—	—	—	—	93.69.0.024
24 V AC/DC	34.81.7.024.xxxx	—	93.66.0.024	93.67.0.024	—	93.69.0.024
(110...125)V AC/DC*	34.81.7.060.xxxx	—	93.66.3.125	—	—	—
(220...240)V AC*	34.81.7.060.xxxx	—	93.66.3.230	—	—	—
(110...125)V AC/DC	34.81.7.060.xxxx	93.60.0.125	93.66.0.125	93.67.0.125	93.65.0.125	—
(24...240)V AC/DC	34.81.7.024.xxxx	—	93.66.0.240	—	—	—
(220...240)V AC	34.81.7.060.xxxx	93.60.8.230	93.66.8.230	93.67.8.230	93.65.8.230	—
6 V DC	34.81.7.005.xxxx	93.60.7.024	93.66.7.024	93.67.7.024	93.65.7.024	—
12 V DC	34.81.7.012.xxxx	93.60.7.024	93.66.7.024	93.67.7.024	93.65.7.024	—
24 V DC	34.81.7.024.xxxx	93.60.7.024	93.66.7.024	93.67.7.024	93.65.7.024	—
60 V DC	34.81.7.060.xxxx	—	93.66.7.060	—	—	—
(110...125)V DC	34.81.7.060.xxxx	—	93.66.7.125	—	—	—
220 V DC	34.81.7.060.xxxx	—	93.66.7.220	—	—	—

* Leakage current suppression



93.69

Approvals
(according to type):



Accessories	
16-way jumper link	093.16 (blue), 093.16.0 (black), 093.16.1 (red)
Dual-purpose plastic separator	093.60
Terminal doubler	093.62
Sheet of marker tags	060.48 and 093.48
Technical data	
Rated values	6 A - 250 V
Dielectric strength	6 kV (1.2/50 μs) between coil and contacts
Protection category	IP 20
Ambient temperature	°C -40...+70
Wire strip length	mm 8
Max wire size	Solid wire and stranded wire
	mm ² 1 x (0.5...2.5)
	AWG 1 x (21...14)

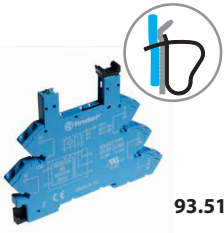

93.51

Screw less terminal socket 35 mm rail mounting (EN 60715)**Common features**

- Space saving 6.2 mm wide
- Connections for 20-way jumper link
- Integral coil indication and protection circuit
- Secure retention and easy ejection by plastic clip

For technical data and supply versions, refer to the **38 Series** – “Relay interface module”Approvals
(according to type):RINA cRU[®] US
 Certain relay/socket combinations
Electromechanical Relay - EMR and Solid State Relay - SSR

Supply voltage	Relay type (reference with the 38 Series)		Socket type
	Electromechanical relay - EMR (38.61.....)	Solid State Relay - SSR (38.81.....)	
12 V AC/DC	34.51.7.012.xx10	—	93.51.0.024
24 V AC/DC	34.51.7.024.xx10	—	93.51.0.024
(110...125)V AC/DC	34.51.7.060.xx10	34.81.7.060.xxxx	93.51.0.125
(220...240)V AC/DC	34.51.7.060.xx10	34.81.7.060.xxxx	93.51.0.240
(110...125)V AC/DC*	34.51.7.060.xx10	34.81.7.060.xxxx	93.51.3.125
(220...240)V AC*	34.51.7.060.xx10	34.81.7.060.xxxx	93.51.3.240
(220...240)V AC	34.51.7.060.xx10	34.81.7.060.xxxx	93.51.8.240
12 V DC	34.51.7.012.xx10	34.81.7.012.xxxx	93.51.7.024
24 V DC	34.51.7.024.xx10	34.81.7.024.xxxx	93.51.7.024
60 V DC	34.51.7.060.xx10	34.81.7.060.xxxx	93.51.7.060

* Leakage current suppression

Accessories

20-way jumper link	093.20
Plastic separator	093.01
Sheet of marker tags	093.48

Technical data

Rated values	6 A - 250 V
Dielectric strength	6 kV (1.2/50 μs) between coil and contacts
Protection category	IP 20
Ambient temperature ($U_N \leq 60$ V / > 60 V)	°C -40...+70 / -40...+55
Wire strip length	mm 10
Max wire size	Solid wire and stranded wire
	mm ² 1 x 2.5 / 2 x 1.5
	AWG 1 x 14 / 2 x 16



93.11

Approvals
(according to type):



PCB socket with retaining and release clip	93.11 (blue)
For relay type	34.51, 34.81
Technical data	
Rated values	6 A - 250 V
Dielectric strength	≥ 6 kV (1.2/50 μs) between coil and contacts
Protection category	IP 20
Ambient temperature	°C -40...+70

A

Retaining and release clip use:

